

Retail Products Catalog

Life Is 

SQUARE ™

by Schneider Electric



www.schneider-electric.us

Authorized Partner



**dealers
electrical
supply**



Table of Contents

► Overview

About Us 4

► Product Definitions

Types of Circuit Breakers,
Residential Load Centers &
other Electrical Devices 6

► QO® Product Information

Introduction to QO Circuit Breakers 8

- Full Size 3/4" Circuit Breakers 9
- Tandem Breakers 10
- GFCI Breakers 10
- CAFCI Breakers 11
- Plug-on Neutral 11
- Dual Function (CAFCI + GFCI) Breakers 12
- TIME SAVER Diagnostics 32
- Accessories: Load Center
and Circuit Breaker 13

► Homeline® Product Information

Introduction to Homeline Circuit Breakers 16

- Full Size 1" Circuit Breakers 17
- Tandem Breakers 18
- CAFCI Breakers 18
- GFCI Breakers 19
- Dual Function (CAFCI + GFCI) Breakers 19
- Plug-on Neutral 20
- TIME SAVER Diagnostics 20

Introduction to Homeline Load Centers 21

▶ Control Switches

Introduction to Control Switches	22
•Float Switches	23-24
– Sump or Open Tank	23
– Closed Tank	24
•Pressure Switches	25-26
– Water Pump	25
– Air Compressor	26

▶ Safety Switches, Surge Protection & Other Residential Products

Introduction	28
•AC Disconnects	29
•Light Duty Safety Switches	29
•General Duty Safety Switches	30
•Circuit Breaker Enclosures	31
•Surge Protection	32
•Generator Panels	33

▶ Advanced Products

Introduction	34
•Wiser Air Thermostat	35-36
•EV Link Charging Stations	38
– Indoor Charging Stations	38
– Outdoor Charging Stations	39
– Vehicle Charging Station Dimensions	40

▶ Important Information

Warranty Information	42
----------------------------	----

About Us

Who we are

Schneider Electric is the global specialist in energy management and automation. Our 170,000 employees serve customers in over 100 countries, helping them to manage their energy and process in ways that are safe, reliable, efficient and sustainable. From the simplest of switches to complex operational systems, our technology, software and services improve the way our customers manage and automate their operations. Our connected technologies will reshape industries, transform cities and enrich lives.

At Schneider Electric, we call this Life Is On.

A history of circuit protection, reliability and innovation

- **1902** As Detroit Fuse and Manufacturing, the company built enclosed fuses and fuse switches to enhance safety in the growing auto plants of Detroit
- **1917** The company changed the name to Square D to capitalize on the high recognition of the trademark on its switches. (a capital D in a square)
- **1926** The company built its first power distribution panel
- **1929** Square D began producing circuit breakers under license from Westinghouse
- **1930** Launched its own range of circuit breakers and the first circuit breaker for residential use
- **1955** Introduced Qwik-Open™ circuit breakers and load centers, known as QO™

- **1968** Added Visi-Trip™ positive trip indicator feature for QO breaker range
- **1971** Introduced Qwik-Gard™ ground fault circuit interrupting (GFI) devices
- **1991** Introduced Homeline™ circuit breakers and load centers
- **1999** Introduced Arc-D-Tect™ arc fault circuit interrupting (CAFI) devices
- **2011** Introduced TIME SAVER Diagnostics in CAFI devices
- **2012** Introduced QO Plug-on Neutral Breakers
- **2014** Introduced 2-Pole CAFI devices
- **2014** Introduced Dual Function circuit breakers, GFI and CAFI in one device
- **2014** Introduced Homeline Plug-on Neutral breakers and load centers

A new business perspective

Innovation is nothing new to Schneider Electric. Our quality, innovation and reliability make us the most preferred brand among electrical contractors and home builders. We attribute much of our success to our customers and work every day to ensure our bright futures together.



BOTTOM
↓
This side is facing down
when the window is installed.
Please do not reverse the
window.

Types of Circuit Breakers, Residential Load Centers & other Electrical Devices

Circuit Breakers: A circuit breaker is designed to protect the wiring in a home. It automatically interrupts a circuit (shutting off the flow of electricity) whenever a circuit is overloaded or a short circuit occurs. Circuit breakers carry three primary ratings:

1. **Ampere Rating:** the specific continuous current on which the breaker is designed to operate
2. **Maximum Voltage Rating:** either 120 Vac for single-pole (one space) breakers or 240 Vac for double-pole (two space) breakers
3. **Interrupting Rating:** the maximum fault current a breaker is designed to interrupt

Single-Pole Circuit Breaker

Available in various ampere ratings, these circuit breakers occupy one space in the load center and are used for single 120 Vac circuits. A typical residential service contains electrical branch circuits supplying wall receptacles, lighting fixtures and appliances such as dishwashers and disposals.

Double-Pole Circuit Breaker

Also available in various ampere ratings. Appliances which require larger amounts of power (clothes dryers, ranges, furnaces, air conditioners, etc.) will use separate 30A, 40A, or 50A 240 Vac branch circuits.

Tandem Circuit Breaker

These low amperage breakers provide two isolated single-pole circuits utilizing only one single-pole space in the load center. Only designated Square D load centers will accept tandem breakers.

Quad Circuit Breaker (Homeline only)

This circuit breaker provides three isolated circuits (two single-pole and one double-pole) utilizing two spaces in the load center. Only designated Homeline load centers will accept quad breakers.

Circuit Breaker Application Guide

Local codes may vary. Check with your electrical inspector for applicable codes.

Circuit Breaker Application	Circuit Breaker		Copper Wire Size
	Amps	# Spaces	
Air Conditioner			
120V – up to 11K BTU	20	1	12-2*
240V – up to 23K BTU	20	2	12-2*
240V – up to 36K BTU	30	2	10-2*
Attic Fan			
120V – up to ½ HP	15	1	14-2
Branch Circuit			
120V – 15A	15	1	14-2
120V – 20A	20	1	12-2
Clothes Dryer			
240V	30	2	10-3
Dishwasher			
120V	20	1	12-2
Doorbell Transformer – Class 5			
120V	15	1	14-2
Electric Heater			
120V – up to 1.92KW	20	1	12-2
Electric Range			
240V – up to 5.7KW	30	2	10-3
240V – up to 7.6KW	40	2	6-3
240V – up to 9.6KW	50	2	6-3
240V – up to 11.5KW	60	2	6-3
Garbage Disposal			
120V – up to ½ HP	15	1	14-2
Motors (Single Phase)			
120V – up to ½ HP	20	1	12-2
120V – up to 1 HP	20	1	12-2
240V – up to 1 HP	15	2	14-2
240V – 1½ to 3 HP	30	2	10-2
Outdoor Lighting:			
120V	15	1	14-2
Range Hood			
120V	15	1	14-2
Spa/Hot Tub			
240V	50-60	2	6-2
Sump Pump			
120V	15	1	14-2
Water Heater			
240V – up to 6KW	25 or 30	2	10-3
Well Pump: up to 1 HP			
120V – up to 150'	30	1	8-2
240V – 151' to 200'	15	1	12-2
240V – 201' to 300'	15	1	10-2

* With ground.

Main Circuit Breaker (for replacement or conversion)

Available in various amperage ratings, this is the main circuit breaker for the load center. It may be ordered to replace the existing main breaker in a main breaker load center or to convert selected main lugs load centers into main breaker load centers.

Advanced Function Circuit Breakers:

- **Ground Fault Circuit Interrupters (GFCI's):**
GFCI's are designed to protect people from the dangers of electrical shock. These circuit breakers are typically installed on circuits where water sources may be present. The National Electrical Code (NEC) requires ground fault circuit protection in the garage, outdoor areas, bathrooms, and in spa areas within the home. The QO™ and Homeline™ Ground Fault Circuit Breakers provide Class A protection, sensing and responding to very low levels of ground faults by tripping and shutting off power, preventing serious electrical shock to people.
- **Combination Arc Fault Circuit Interrupters (CAFCI's):** CAFCI's provide protection against series and parallel arcs. Arcing is a precursor to many electrical fires. Square D QO and Homeline CAFCI's help protect people and property from fires caused by electrical arcing. These devices continuously monitor the branch circuit and trip when a potentially dangerous condition is detected.
- **Dual Function (CAFCI + GFCI) Two critical, state-of-the-art technologies in one device:** The innovative Square D QO and Homeline Dual Function Circuit Breakers combine two critical, state-of-the-art technologies: Combination Arc Fault and Ground Fault (Class A) Protection in one circuit breaker. Dual Function Circuit Interrupters provide a higher level of protection than any other residential circuit breaker. These devices protect the entire circuit on which they are installed, not just a part of the circuit like electronic receptacles do.

Main Breaker Load Centers

This is the service entrance panel which is connected to the electrical meter and distributes electricity throughout the home. Each is equipped with a factory installed main circuit breaker, which serves as the main disconnect to turn off power to the entire home, as well as to protect the load center from an overload or short circuit.

Main Lugs Load Centers

This is typically used as an add-on or "sub panel" load center and is connected to the main breaker load center when spaces for more circuits are needed or when a main disconnect is located elsewhere. It does not contain a main breaker. Convertible main lug panels can be converted to main breaker panels with a replacement main breaker.

Safety Switches

These are designed for residential and light commercial applications where operation and handling are moderate. Typical applications include residential, farm and small business service entrances and light-duty branch circuit disconnects.

Pressure Switches

These devices are designed for the control of water pumps and air compressors. They are available in a variety of pressure settings and cutoff levels.

Enclosed Circuit Breakers

These devices include provisions for a double-pole circuit breaker to be installed in an enclosure. Typical applications include a main service entrance disconnect for mobile homes and residences, as well as equipment or outbuilding disconnects.

Meter Sockets

These individual meter sockets are designed for single family residential applications. They are the point of placement for the utility company's detachable watt hour meter and are used in conjunction with a load center located inside the home. The enclosures are of rainproof construction and accept "A" type bolt-on hubs for conduit entry.

- **Ring Type**
A ring type meter socket uses a sealing ring to retain the meter in position. In order to remove the meter, the sealing ring is removed without removing the cover.
- **Ringless Type**
A ringless type meter socket uses the cover itself as a retaining means to hold the meter in position. To remove the meter, the cover must first be removed.

Combination Service Entrance Devices (CSED)

CSEDs primarily serve the West Coast residential market. "All-in-one" devices combine the meter socket, main disconnect and load center into one enclosure. "Meter mains" combine the meter socket and main breaker disconnect in the same enclosure.

QO Circuit Breakers

QO Visi-Trip Indicator

All QO circuit breakers are equipped with the Visi-Trip™ indicator. When a Visi-Trip circuit breaker trips, the handle snaps to a midpoint position between “OFF” and “ON” and a highly visible, red indicator easily identifies the tripped breaker. This enables you to easily distinguish which breaker has tripped in a load center that may contain up to 60 different circuit breakers.

QO circuit breakers have features no other manufacturer can offer. They come in many different sizes and can meet the needs of virtually every function in your home or business. These types of quality, industry exclusive products keep the Square D brand ahead of the competition and are builders’ and electrical contractors’ first choice in electrical protection.

QO Circuit Breaker Features:

- Qwik-Open™ circuit breaker protection (trips within 1/60th of a second) on 15A and 20A single-pole breakers at currents as low as 150A to 200A
- Trips thermally (in an overload situation) or magnetically (under a short circuit situation)
- SWD (switching duty) rating on 15A and 20A single-pole breakers
- Plug-on Neutral design available, saving you money with quicker installation times*
- Limited lifetime warranty (see page 82 for details)

* The Plug-on Neutral Advantage:

- *Faster installation – Fewer connections*
- *Saves wire – Fully distributed split neutral bar*
- *Frees gutter space – No pigtails*
- *Easier troubleshooting – TIME SAVER Diagnostics provide additional circuit information at the touch of a button*
- *Faster and easier wiring – All spaces accept tandems*



For over half a century, QO products have been the choice of professionals – chosen two to one over any other brand. The quality and protection standards of the QO line lead the industry by providing unsurpassed protection and reliability.

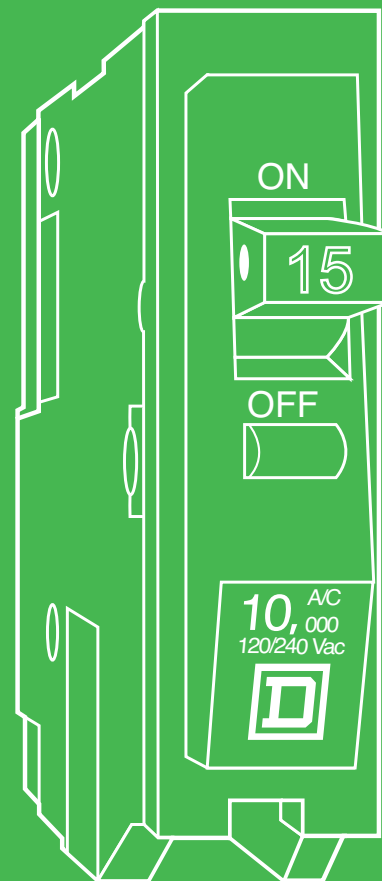

QO Circuit Breakers

3/4" Breaker Catalog Number Description			
QO	1	15	C
Brand	# of Poles	Amps	Clam Shell Packaging

"C" denotes clam shell packaging.
 "CP" denotes bulk bar coded breakers.

3/4" Breaker*				
Amps	1-Pole Catalog #	UPC Code	2-Pole Catalog #	UPC Code
15	QO115CP▲	0-47569-83798-2	QO215CP	0-47569-00894-8
	QO115C▲	0-47569-52237-6	QO215C	0-47569-52216-1
20	QO120CP▲	0-47569-83799-9	QO220CP	0-47569-83802-6
	QO120C▲	0-47569-52238-3	QO220C	0-47569-52217-8
25	—	—	QO225CP	0-47569-02382-8
30	QO130CP	0-47569-83800-2	QO230CP	0-47569-83803-3
	QO130C	0-47569-52239-0	QO230C	0-47569-52218-5
40	QO140CP	0-47569-83801-9	QO240CP	0-47569-83804-0
	QO140C	0-47569-17791-0	QO240C	0-47569-52219-2
50	QO150CP	0-47569-00893-1	QO250CP	0-47569-83805-7
	—	—	QO250C	0-47569-52220-8
60	—	—	QO260CP	0-47569-83806-4
	—	—	QO260C	0-47569-52221-5
70	—	—	QO270CP	0-47569-00895-5
80	—	—	QO280CP	0-47569-52227-7
90	—	—	QO290CP	0-47569-52228-4
100	—	—	QO2100CP	0-47569-52229-1
	—	—	QO2100C	7-85901-69123-5
125	—	—	QO2125CP	0-47569-04400-7

High Magnetic 3/4" Breakers*		
Amps	1-Pole Catalog #	UPC Code
15	QO115HM	7-85901-40007-3
20	QO120HM	7-85901-40011-0

* All 15A to 60A circuit breakers listed on this page are UL listed as HACR type for use with air conditioning, heating and refrigeration equipment having motor group combinations and marked for use with HACR type circuit breakers.
 ▼ 10A to 30A circuit breakers are suitable for use with 60°C or 75°C conductors. 35A to 125A circuit breakers are suitable for use with 75°C conductors.
 ▲ UL listed as SWD (switching duty) rated. Suitable for switching 120 Vac fluorescent lighting loads.

Plug-On Circuit Breakers

- UL Listed, CSA Approved
- 120/240 Vac
- 10k AIR
- Visi-Trip Indicator



QO120



QO2100

QO Circuit Breakers – Tandem

Tandem Catalog Number Description			
QO	T	15	15
Brand	Tandem Breakers	1st Pole Amps	2nd Pole Amps

"C" denotes clam shell packaging.

"CP" denotes bulk bar coded breakers.

Amps▼		1-Pole Catalog #	UPC Code	2-Pole Tandem
1-Pole	2-Pole			
Tandem Breakers 1-Pole (120/240 Vac) and 2-Pole				
15	15	QOT1515CP	0-47569-06269-8	Order two QOT1515 or QOT2020 circuit breakers and handle tie, catalog #QOTHT, for common switching of center double-poles.
20	20	QOT2020CP QOT2020C	0-47569-00896-2 0-47569-07198-0	

Replacement Tandem Breakers				
For use in Old Style Non-Class CTL QO Load Centers (built prior to 1967)				
15	15	QO1515CP QO1515C	0-47569-08277-1 0-47569-07195-9	Order two QO1515 or QO2020 circuit breakers and handle tie, catalog #QOTHT, for common switching of center double-poles.
20	20	QO2020CP QO2020C	0-47569-00898-6 0-47569-07196-6	

▼ 10A to 30A circuit breakers are suitable for use with 60°C or 75°C conductors. 35A-125A circuit breakers are suitable for use with 75°C conductors.

Plug-On Circuit Breakers

- UL Listed, CSA Approved
- 120/240 Vac
- 10k AIR
- Visi-Trip Indicator



QOT1515

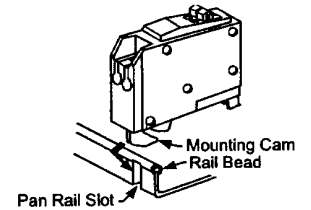

Circuit Limiting QOT Tandem Breakers

QOT tandem breakers have a mounting cam as shown. Installation into a QO load center can only be made in those positions having a mounting pan rail slot. UL listed as class CTL.

QO Circuit Breakers – GFCI

GFCI Catalog Number Description			
QO	1	15	GFI
Brand	# of Poles	Amps	Ground Fault Circuit Interrupter

GFCI Breakers: 1-Pole (120 Vac) and 2-Pole (120/240 Vac)				
Amps▼	1-Pole Catalog #	UPC Code	2-Pole Catalog #	UPC Code
15	QO115GFCIP●	0-47569-52231-4	QO215GFI*+	7-85901-56298-6
20	QO120GFCIP●	0-47569-52232-1	QO220GFCIP	0-47569-83831-6
30	QO130GFI*	7-85901-25509-3	QO230GFCIP	0-47569-03467-1
40	—	—	QO240GFCIP	0-47569-03468-8
50	—	—	QO250GFCIP●	0-47569-04392-5
60	—	—	QO250GFCIP	0-47569-04392-5
60	—	—	QO260GFCIP▶	0-47569-04393-2

Circuit Breaker Wire Sizes			
Breaker Type	Amp Rating▼	Wire Size (AWG)	
		Aluminum	Copper
QO	10-30	#14 - 8	(1) #14 - 8 or (2) #14 - 10
	35-70	#8 - 2	#8 - 2
	80-125	#12 - 2/0	#12 - 2/0
QOT	15-20	#12 - 8	#14 - 8
QO-GFI	15-30	#12 - 8	#14 - 8
	40, 50, 60	#12 - 4	#14 - 6

GFCI Breakers & Application Info

- UL Listed, CSA Approved
- QOE250GFINM Value Pack (see Page 59)
- 120/240 Vac
- 10k AIR
- GFI: Yellow Reset Button



QO120GFI



QO250GFI

- ▶ Suitable only for feeding 240 Vac and 208 Vac 2 wire loads. Does not contain load neutral connection.
- Only available in clam shell packaging.
- ▼ 10A to 30A circuit breakers are suitable for use with 60°C or 75°C conductors. 35A-125A circuit breakers are suitable for use with 75°C conductors.
- Do not connect to more than 250 feet of load conductor for the total one-way run to prevent nuisance tripping.
- ✦ Item may require additional lead time.

QO Circuit Breakers – CAFCI

Combination Arc Fault Circuit Interrupters could prevent more than 50 percent of the electrical fires that occur every year (U.S. Consumer Product Safety Commission estimate). Square D Combination Arc Fault Circuit Interrupters (AFCIs) are the first commercially available circuit breaker designed to meet the National Electrical Code® (NEC) requirements for Combination AFCI protection.

Combination AFCI's, also known as Combination Arc Fault (CAFI) Circuit Breakers sense and respond to a broader range of arcing incidents than the standard AFCI circuit breakers, providing superior protection against electrical fires for homes and families. Series arcing is often associated with damaged devices or cord sets. A series arc is an arcing incident across a break in a conductor.

A common example is a cut across one of the two wires in a lamp cord, with a dangerous arc forming in the gap. The CAFI Circuit Breaker detects the arcing condition and turns off or trips the circuit, thus providing the enhanced electrical safety and protection. Square D Combination Arc Fault Circuit Breakers are UL® listed, available in QO and Homeline 1-Pole and 2-Pole circuit breakers with 15 and 20 ampere ratings.

CAFCI Circuit Breakers

- UL Listed, CSA Approved
- 120/240 Vac
- 10k AIR
- CAFI: White Reset Button
- Protects against series and parallel arcs

Amps	1-Pole Catalog #	UPC Code	2-Pole Catalog #	UPC Code
Combination Arc-fault Interrupter (Pigtail Neutral)				
15	QO115CAFIC	7-85901-61044-1	QO215CAFIC	7-85901-38947-7
20	QO120CAFIC	7-85901-69818-0	QO220CAFIC	7-85901-39098-5
Combination Arc-fault Interrupter (Plug-on Neutral)				
15	QO115PCAFIC	7-85901-96528-2	—	—
20	QO120PCAFIC	7-85901-97843-5	—	—



QO215CAFI



QO120PCAFI Plug-on Neutral

QO Circuit Breakers – Plug-on Neutral (PoN)

Engineered for a quick Plug-on Neutral connection on every circuit.

QO Plug-on Neutral (QO PoN) Load Centers are designed to reduce installation time of CAFI and Dual Function Circuit Breakers. Installing QO Plug-on Neutral Circuit Breakers eliminates the pigtail connection, clearing the wire gutter and speeding up the job. The mounting rail of plug-on neutral load center is engineered with a plated neutral bar that accepts all QO Circuit Breakers and is similar to the thermoplastic rail of standard QO load centers, but allows for the Plug-on Neutral Circuit Breakers to be connected on any circuit. A comprehensive selection of QO Plug-on Neutral Load Centers are available to meet your specific needs.

Single phase only

- 100 and 200 amps Main breaker 125, 200 and 225A main lug devices available
- 24, 30, 42, 54 and 60 full-size spaces/circuits
- Option for surface or flush covers that ship separately, or a combo cover (in carton) shipped with load center
- Accepts both QO PoN and pigtail Advanced Function Circuit Breakers, and all standard QO Circuit Breakers and QO accessories
- The QO Plug-on Neutral Load Center offers are additions to the standard QO offer*

* Standard QO load centers will not accept Plug-on Neutral circuit breakers.

The QO Plug-on Neutral Advantage

- The QO Plug-on Neutral Load Center interior is engineered for a quick Plug-on Neutral connection on every circuit.
- Features an innovative connector jaw that is integral to the Plug-on Neutral Circuit Breaker, eliminating the pigtail connection providing cleaner gutter space
- Straight-in wiring and uniform termination lugs help minimize cable bends, reducing waste and minimizing installation time
- Standard 22kA/10kA series short circuit current rating on main breaker load centers provides increased application capabilities
- Backed Out Neutral Screws save labor and installation time
- Features all of the QO Load Center benefits, now available with a quick Plug-on Neutral connection.

QO Circuit Breakers – Dual Function

Save time and money with combined Combination Arc Fault Protection and Ground Fault Protection in one device.

The innovative Square D QO Dual Function Circuit Breaker saves space and installation time while meeting prevailing National Electric Code® requirements. Available in both standard Pigtail and time-saving Plug-on Neutral configurations, these circuit breakers combine two state-of-the-art technologies; Combination Arc Fault and Ground Fault protection, in a single, easy-to-install device. The Dual Function Circuit Breaker offers superior electrical safety for homeowners.

The 2014 National Electric Code now requires both Combination Arc Fault and Ground Fault protection on all 1-Pole, 15A, and 20A kitchen and laundry circuits. Prior to the release of the Dual function Circuit Breaker, a contractor or homeowner's only choice was to use a Combination Arc Fault circuit breaker in conjunction with an expensive, bulky Ground Fault receptacle. The new Dual Function circuit breakers help reduce cost and eliminate the hassle of using two separate devices to provide essential protection. It's a win for contractors and homeowners alike. Like all Square D CAFI Circuit Breakers, it is integrated with TIME SAVER Diagnostics (Page 32), a unique feature that provides additional circuit information and minimizes troubleshooting at the touch of a button.

Dual Function Breakers

- UL Listed, CSA Approved
- 120 VAC
- 15-20 A current rating
- Interrupt Ratings:
 - HOM, QO, and QOB – 10 kA
 - QOVH and QOB VH – 22 kA
- DF: Purple Reset Button

Dual Function Circuit Breakers				
	Pigtail Neutral		Plug-On Neutral	
Amps	1-Pole Catalog #	UPC Code	1-Pole Catalog #	UPC Code
15	QO115DFC	7-85901-40166-7	QO115PDFC	7-85901-98385-9
20	QO120DFC	7-85901-40168-1	QO120PDFC	7-85901-98347-7

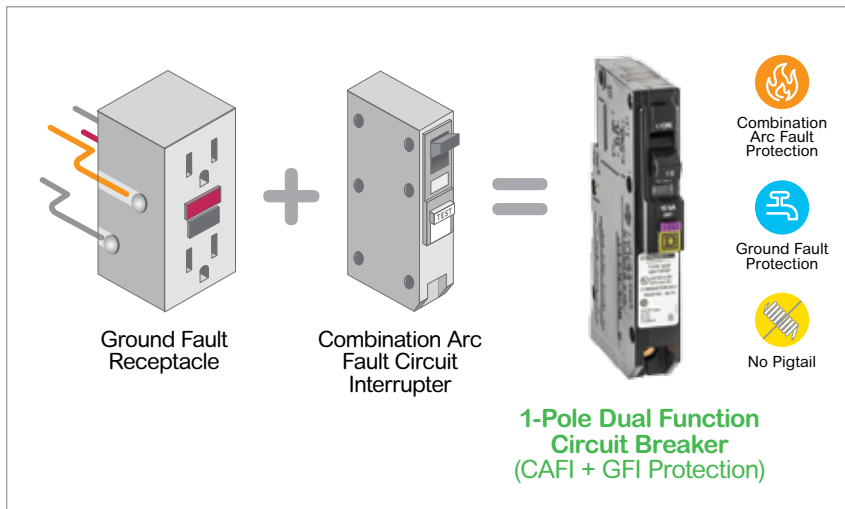

QO & Homeline – Accessories

Accessory	Description	Catalog #	UPC Code**
Handle Attachments			
Retaining Kit	Secured as back-fed main for HOM612L100F/S, RB, HOM48L125C,GRB load centers	HOM1RKCP	0-47569-07145-4
Handle Tie	Converts any two adjacent 120/240 Vac 1-pole Homeline circuit breakers to independent trip 2-pole	HOM1HTCP	0-47569-07147-8
	Converts any two adjacent 120/240 Vac 1-pole QO circuit breakers to independent trip 2-pole	QO1HTCP	0-47569-57040-7
	Converts any two adjacent 120/240 Vac 1-pole side-by-side Homeline tandem breakers to independent trip 2-pole	HOMTHTCP	0-47569-07148-5
	Converts any two adjacent 120/240 Vac 1-pole side-by-side QOT circuit breakers to independent trip 2-pole	QOTHTCP	0-47569-17831-3
Handle Lock-Off	Clip for fixing QO 1-pole handle in "ON" or "OFF" position	QO1LOCP	0-47569-49462-8
	Clip for fixing QO or Q1 either 1-, 2- or 3-pole breaker handles in "ON" or "OFF" position	HLO1CP	0-47569-51772-3
Handle Padlock Attachment	For padlocking 1-pole Homeline breakers in "ON" or "OFF" position	HOM1PACP	0-47569-79871-9
	For padlocking 2-pole Homeline breakers in "ON" or "OFF" position		
	– For high amperage	HOM2PAHACP	7-85901-33158-2
	– For low amperage	HOM2PALACP	7-85901-33159-9
	For padlocking the center of a 2-pole Homeline quad breaker in the "OFF" position	HOMQPA+	7-85901-86581-0
	For padlocking 1-pole QO circuit breakers in "ON" or "OFF" position		
	– Fixed attachment	QO1PACP	0-47569-49743-8
	– Loose attachment	QOHP+	7-85901-76347-5
Mechanical Interlock Attachment with Retaining Kit	For padlocking 1-pole side-by-side QOT circuit breakers in "ON" or "OFF" position.	QOTHPA+	7-85901-00255-0
	For 2- and 3-pole QO and Q1 circuit breakers which require padlocking in either "ON" or "OFF" position		
	– Fixed attachment	QO1PL+	7-85901-51907-2
	– Loose attachment	QO1HPLCP	0-47569-79864-1
	For padlocking 1-pole CAFI, DF, GFI, and EPD HOM breakers in "ON" or "OFF" position.	HOMELEC1PA	7-85901-70872-8
Mechanical Interlock Attachment with Retaining Kit	For padlocking 2-pole CAFCI, GFI, and EPD HOM breakers in "ON" or "OFF" position.	HOMELEC2PALA	7-85901-72572-5
	QO2DTI mechanical interlock attachment with retaining kit for securing two adjacent back-fed circuit breakers in dual power supply applications. Can be used with (2) 2-poles or (1) 2-pole and (1) 1-pole QO circuit breakers in QO816L100 load centers.	QO2DTIM+	7-85901-78471-5
Bolt-On Hubs	Meter socket Bolt-On "A" hub	A100	7-85901-02948-9
		A125	7-85901-02949-6
		A150	7-85901-02950-2
		A200	7-85901-02951-9
		A200L	7-85901-13009-3
		A250	7-85901-02952-6
		A250L	7-85901-10798-9
		A300L	7-85901-10797-2
	Outdoor Bolt-On "B" hub	B075	7-85901-45941-5
		B100	7-85901-45942-2
		B125	7-85901-45944-6
		B150	7-85901-45945-3
		B200	7-85901-45947-7
		B250	7-85901-45948-4
		B300	7-85901-61583-5



Accessory	Description	Catalog #	UPC Code**
Sub-Feed Lugs	2-pole plug-on – 2 spaces required		
	– 125A	HOML2125+	7-85901-06592-0
	– 60A (#6 - 2 Al/Cu) – 125A (#4 - 2/0 Al/Cu)	QO60SL QO2125SL+	Special Order 7-85901-03115-4
Filler Plates	Fills opening in covers if twistout is removed in error	HOMFPCP	7-85901-07149-2
		QOFPCP	0-47569-07224-6
Closing Plates	To be installed on TOP endwall	ACPACP	0-47569-73540-0
		ACPCP	0-47569-73539-4
Lock Kits	Use with convertible load center covers (Indoor)	PK6FL+	7-85901-74631-7
Neutral Lugs/ Ground Lugs	Field installed for #12 - 2 Al or #14 - 4 Cu wire	LK70ANCP▲	7-85901-48311-3
		HOM70ANCP	0-47569-73532-5
		QO70ANCP	0-47569-91173-6
	Field installed for #6 - 2/0 Al/Cu wire	LK100ANCP▲	7-85901-43664-2
		HOM100ANCP	0-47569-73534-9
	Field installed for #2 - 3/0 Al/Cu wire	LK150AN▲+	7-85901-73835-0
Ground Bar Kits	Standard PK15GTA with a #1 - 4/0 Al/Cu Lug	PK15GTAL+	7-85901-44087-1
	Standard PK18GTA with a #1 - 4/0 Al/Cu Lug	PK18GTAL+	7-85901-44088-8
	Standard PK23GTA with a #1 - 4/0 Al/Cu Lug	PK23GTAL+	7-85901-44089-5
Ground Bars Number of terminals listed at right. All suitable for: (1) #14 - 4 or (2) #14 or #12 Cu or (1) #12 - 4 or (2) #12 or #10 Al	Two terminals suitable for (1) #10 - 2/0 Cu or (1) #6 - 2/0 Al	PK0GTA2	7-85901-43267-8
	Three terminals	PK3GTA1CP	0-47569-51730-3
	Four terminals	PK4GTACP	0-47569-51731-0
	Seven terminals	PK7GTACP	0-47569-51732-7
	Nine terminals	PK9GTACP	0-47569-51733-4
	Twelve terminals	PK12GTACP	0-47569-51735-8
	Fifteen terminals	PK15GTACP	0-47569-57033-9
	Eighteen terminals	PK18GTACP	0-47569-51738-9
	Twenty-three terminals	PK23GTACP	0-47569-51739-6
	Miscellaneous		
Retaining Kit	Secures circuit breaker to interior when used as a back-fed main. For QO612L100F/S,RB, QO612L100DF/S, QO816L100F/S,RB and QO816L100DF/S load centers.	PK2MBCP	0-47569-51734-1
	Secures ONE circuit breaker, with or without electrical accessories, to right side of interior when used as a back-fed main. For 100 to 125A convertible main load centers. Series S01 and S02.	PK4MB2LA+	7-85901-30718-1
	Secures ONE circuit breaker, with or without electrical accessories, to right side of interior when used as a back-fed main. For 150 to 225A convertible main load centers. Series S01 and S02.	PK4MB2HA+	7-85901-30717-4
Manual Transfer Equipment Transfer	Secures TWO circuit breakers to right side of interior when used as back-fed mains, a QO2DTI Kit included for back-up power supply applications. For 100A to 125A convertible main load centers. Series S01 and S02.	PK4DTIM4LA+	7-85901-40027-1
	Secures TWO circuit breakers to right side of interior when used as back-fed mains, a QO2DTI Kit included for back-up power supply applications. For 150A to 225A convertible main load centers. Series S01 and S02.	PK4DTIM4HA+	7-85901-30716-7
	Secures TWO circuit breakers to left side of interior when used as back-fed mains, a QO2DTI Kit included for back-up power supply applications. For 100A to 125A convertible main load centers. Series S01 and S02.	PK4DTIM4LAL+	7-85901-30721-1
Cover Screws	Clamshell package of six load center cover screws. Fits all QO and Homeline load centers.	S106	0-47569-44073-1
Surge Protector Mounting Kit	UL listed for mounting hardwired SDSA1175 surge arrester into ground bar mounting holes on convertible load centers.	QOSAMK	7-85901-00298-7

Accessories

- UL Listed
- QO accessories can only be used with QO load centers



PK7GTACP



ACPCP



LK100ANCP



S106

* For use in QO load centers prior to series S1.

** Where UPC code is not shown, contact Square D sales representative for ordering information.

▲ For use in QO and Homeline load centers.

+ Item may require additional lead time.



Homeline Circuit Breakers

The Best In Class

Homeline Circuit Breakers are built with the same Square D brand quality you have come to expect at a price that makes them the best value in their class.

Homeline Circuit Breaker Features:

- Standard 1" format
- Trip thermally (in an overload situation) or magnetically (under a short circuit situation)
- Switching duty rating (SWD) on 15A and 20A single-pole breakers
- Quick make – quick break mechanism
- Plug-on Neutral design available, saving you money with quicker installation times*
- Limited lifetime warranty (see page 82 for details)

* The Plug-on Neutral Advantage:

- Faster installation – Fewer connections
- Saves wire – Fully distributed split neutral bar
- Frees gutter space – No pigtails
- Easier troubleshooting – TIME SAVER Diagnostics provide additional circuit information at the touch of a button
- Faster and easier wiring – All spaces accept tandems

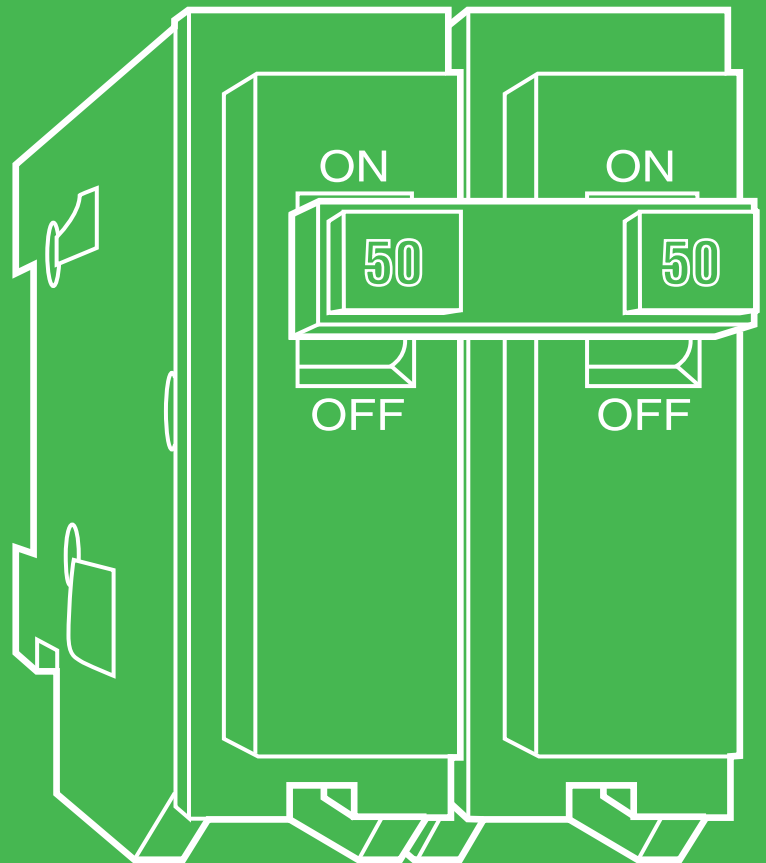

Homeline circuit breakers are the best in class. Designed exclusively for the residential market, Homeline products offer everything you need to distribute electricity throughout your home. Homeline offers the same quality as the QO line with only slight modifications that are tailored to the residential market.

Homeline Circuit Breakers

1" Breaker Catalog Number Description			
HOM	1	15	C
Brand	# of Poles	Amps	Clam Shell Packaging

"C" denotes clam shell packaging.

"CP" denotes bulk bar coded breakers.

Full Size 1" Breakers*				
Amps	1-Pole Catalog #	UPC Code	2-Pole Catalog #	UPC Code
15	HOM115CP▲	0-47569-06270-4	HOM215CP	0-47569-06275-9
	HOM115C▲	0-47569-06287-2	HOM215C	0-47569-06292-6
20	HOM120CP▲	0-47569-06271-1	HOM220CP	0-47569-06276-6
	HOM120C▲	0-47569-06288-9	HOM220C	0-47569-07099-0
25	—	—	HOM225CP	0-47569-07160-7
30	HOM130CP	0-47569-06272-8	HOM230CP	0-47569-06277-3
	HOM130C	0-47569-06289-6	HOM230C	0-47569-07100-3
40	HOM140CP	0-47569-06273-5	HOM240CP	0-47569-06278-0
	HOM140C	0-47569-06290-2	HOM240C	0-47569-07101-0
50	HOM150CP	0-47569-06274-2	HOM250CP	0-47569-06279-7
	—	—	HOM250C	0-47569-07102-7
60	—	—	HOM260CP	0-47569-06280-3
	—	—	HOM260C	0-47569-07103-4
70	—	—	HOM270CP	0-47569-06281-0
80	—	—	HOM280CP	0-47569-06282-7
90	—	—	HOM290CP	0-47569-06283-4
100	—	—	HOM2100CP	0-47569-06285-8
	—	—	HOM2100C	7-85901-48242-0
125	—	—	HOM2125CP	0-47569-06286-5

* UL listed as HACR type for use with air conditioning, heating and refrigeration equipment having motor group combinations and marked for use with HACR type circuit breakers.

▲ 15A to 20A tandem or quad tandem breakers are suitable for use with 60°C or 75°C conductors. 25A to 50A tandem or quad tandem are suitable for use with 75°C conductor only.

Plug-On Circuit Breakers

- UL Listed
- 120/240 Vac
- 10k AIR



HOM120



HOM230

Homeline Circuit Breakers – Tandem

Tandem Catalog Number Description			
HOM	T	15	15
Brand	Tandem Breakers	1st Pole Amps	2nd Pole Amps

"C" denotes clam shell packaging. "CP" denotes bulk bar coded breakers.

Tandem Breakers* 1-Pole (120/240 Vac)			
Amps		1-Pole Catalog #	UPC Code
1st Pole	2nd Pole		
15	15	HOMT1515CP	0-47569-07105-8
		HOMT1515C	0-47569-07107-2
15	20	HOMT1520CP	0-47569-40375-0
		HOMT2020CP	0-47569-07106-5
20	20	HOMT2020C	0-47569-07108-9
		HOMT3020CP	7-85901-40385-2

Quad Tandem Breakers* 2-Pole (120/240 Vac) 2 Spaces Required			
Amps		2-Pole Catalog #	UPC Code
1st Pole	2nd Pole		
(2) 15	15	HOMT1515215	7-85901-06935-5
	20	HOMT1515220CP	0-47569-07220-8
	30	HOMT1515230CP	0-47569-07221-5
	40	HOMT1515240CP	7-85901-39582-9
	50	HOMT1515250CP	7-85901-39583-6
(2) 20	20	HOMT2020220CP	0-47569-07222-2
	30	HOMT2020230CP	0-47569-07223-9
	40	HOMT2020240CP	7-85901-39584-3
	50	HOMT2020250CP	7-85901-39400-6

Plug-On Circuit Breakers

- UL Listed
- 120/240 Vac
- 10k AIR



HOMT1520CP



HOMT2020240CP

NOTE: Homeline load center's accept tandem and Quad breakers.

* UL listed as HACR type for use with air conditioning, heating and refrigeration equipment having motor group combinations and marked for use with HACR type circuit breakers.

▲ 15A to 20A tandem or quad tandem breakers are suitable for use with 60°C or 75°C conductors. 25A to 50A tandem or quad tandem are suitable for use with 75°C conductor only.

Homeline Circuit Breakers – CAFCI

HomeLine Combination Arc Fault Circuit Interrupters

Combination Arc Fault Circuit Interrupters could prevent more than 50 percent of the electrical fires that occur every year (U.S. Consumer Product Safety Commission estimate). Square D Combination Arc Fault Circuit Interrupters (AFCIs) are the first commercially available circuit breaker designed to meet the National Electrical Code® (NEC) requirements for Combination AFCI protection. Combination AFCI's, also known as Combination Arc Fault (CAFI) Circuit Breakers sense and respond to a broader range of arcing incidents than the standard AFCI circuit breakers, providing superior protection against electrical fires for homes and families.

Circuit Breaker Type	Ampere Rating	Pole 120 Vac	Catalog Number	UPC Code
1-Pole				
Combination Arc-Fault circuit Interrupter with Pigtail Neutral	15 A	1	HOM115CAFIC	7-85901-63098-2
	20 A	1	HOM120CAFIC	7-85901-47715-0
Plug-On Neutral Combination Arc-Fault Interrupter	15 A	1	HOM115PCAFIC	7-85901-97878-7
	20 A	1	HOM120PCAFIC	7-85901-97668-4
2-Pole				
Combination Arc-Fault Circuit Interrupter with Pigtail Neutral	15 A	2	HOM215CAFIC	7-85901-40073-8
	20 A	2	HOM220CAFIC	7-85901-40078-3

CAFI Breakers

- UL Listed, CSA Approved
- 120/240 Vac
- 10k AIR
- CAFI: White Reset Button

The CAFI Circuit Breaker detects the arcing condition and turns off or trips the circuit, thus providing the enhanced electrical safety and protection.



HOM115CAFIC



HOM215CAFIC

Homeline Circuit Breakers – GFCI

GFCI Catalog Number Description			
HOM	1	15	GFI
Brand	# of Poles	Amps	Ground Fault Circuit Interrupter

GFCI Breakers: 1-Pole (120 Vac) and 2-Pole (120/240 Vac)				
Amps	1-Pole Catalog #	UPC Code	2-Pole Catalog #	UPC Code
15	HOM115GFICP	0-47569-07109-6	HOM215GFI*	7-85901-30319-0
20	HOM120GFICP	0-47569-07110-2	HOM220GFI*	7-85901-16370-1
30	—	—	HOM230GFI*	7-85901-15287-3
40	—	—	HOM240GFI*	7-85901-21929-3
50	—	—	HOM250GFI	7-85901-78357-2
—	—	—	HOM250GFICP	7-85901-87589-5

Circuit Breaker Wire Sizes			
Breaker Type	Amp Rating	Wire Size (AWG)*	
		Aluminum	Copper
HOM – 1-Pole	15-30*	#14 - 8	(2) #14 - 10
	45-50*	#8 - 2	#8 - 2
HOM – 2-Pole	15-30*	#14 - 8	#14 - 8 or (2) #14 - 10
	35-70*	#8 - 2	#8 - 2
	80-125*	#4 - 2/0	#4 - 2/0
HOMT and QUAD	15-30▲	#14 - 8	#14 - 8
HOM-GFI – 1-Pole	15-20*	#14 - 10	#14 - 10
HOM-GFI – 2-Pole	15-50*	#12 - 4	#14 - 6

GFCI Breakers and Application Info

- UL Listed
- 10k AIR
- HOME250SPA Value Pack (see page 57)



HOM120GFI

HOM240GFI

- * 15A to 30A circuit breakers are suitable for use with 60°C or 75°C conductors. 40A to 125A circuit breakers are suitable for use with 75°C conductors.
- ▲ 15A to 20A tandem or quad tandem circuit breakers are suitable for use with 60°C or 75°C conductors. 25A to 50A tandem or quad tandem circuit breakers are suitable for use with 75°C conductor only.
- ✦ Item may require additional lead time.

Homeline Circuit Breakers – Dual Function

Save time and money with combined Combination Arc Fault Protection and Ground Fault Protection in one device.

The innovative Square D Homeline Dual Function Circuit Breaker saves space and installation time while meeting prevailing National Electric Code® requirements. Available in both standard Pigtail and time-saving Plug-on Neutral configurations, these circuit breakers combine two state-of-the-art technologies; Combination Arc Fault and Ground Fault protection, in a single, easy-to-install device. The Dual Function Circuit Breaker offers superior electrical safety for homeowners.

Dual Function Circuit Breakers				
	Pigtail Neutral		Plug-On Neutral	
Amps	1-Pole Catalog #	UPC Code	1-Pole Catalog #	UPC Code
15	HOM115DFC	7-85901-98601-0	HOM115PDFC	7-85901-97869-5
20	HOM120DFC	7-85901-98341-5	HOM120PDFC	7-85901-98702-4

Dual Function Breakers

- UL Listed, CSA Approved
- 120 VAC
- 15-20 A current rating
- Interrupt Ratings: HOM – 10 kA
- DF: Purple Reset Button



HOM120DF

HOM120PDF

Homeline Circuit Breakers – Plug-on Neutral (PoN)

Engineered for a quick Plug-on Neutral connection on every circuit.

Homeline Plug-on Neutral (PoN) Load Centers are designed to reduce installation time of CAFI and Dual Function Circuit Breakers. Installing Plug-on Neutral Circuit Breakers eliminates the pigtail connection, clearing the wire gutter and speeding up the job. The mounting rail of plug-on neutral load center is engineered with a plated neutral bar that accepts all Homeline Circuit Breakers and is similar to the thermoplastic rail of standard Homeline load centers, but allows for the Plug-on Neutral Circuit Breakers to be connected on any circuit. A comprehensive selection of Plug-on Neutral Load Centers are available to meet your specific needs.

Single phase only

- 100 and 200 amps Main breaker 125, 200 and 225A main lug devices available
- 24, 30, 42, 54 and 60 full-size spaces/circuits
- Use standard Homeline flush or surface mount covers
- Accepts both Homeline PoN and pigtail CAFI Circuit Breakers, and all Homeline Circuit Breakers and accessories
- The Homeline Plug-on Neutral Load Center offers are additions to the standard Homeline offer

The Homeline Plug-on Neutral Advantage

- The Homeline Plug-on Neutral Load Center interior is engineered for a quick Plug-on Neutral connection on every circuit.
- Features an innovative connector jaw that is integral to the Plug-on Neutral Circuit Breaker, eliminating the neutral wire, pigtail connection providing cleaner gutter space
- Straight-in wiring and uniform termination lugs help minimize cable bends, reducing waste and minimizing installation time
- Standard 22kA/10kA series short circuit current rating on main breaker load centers provides increased application capabilities
- Backed Out Neutral Screws save labor and installation time
- Features all of the Homeline Load Center benefits, now available with a quick Plug-on Neutral connection.

TIME SAVER Diagnostics

Troubleshoot Circuit Issues

Eliminate the guesswork with TIME SAVER Diagnostics to identify the type of fault that last occurred.

The TIME SAVER Diagnostics sequence is simple and easy to use and requires no tools or special training.

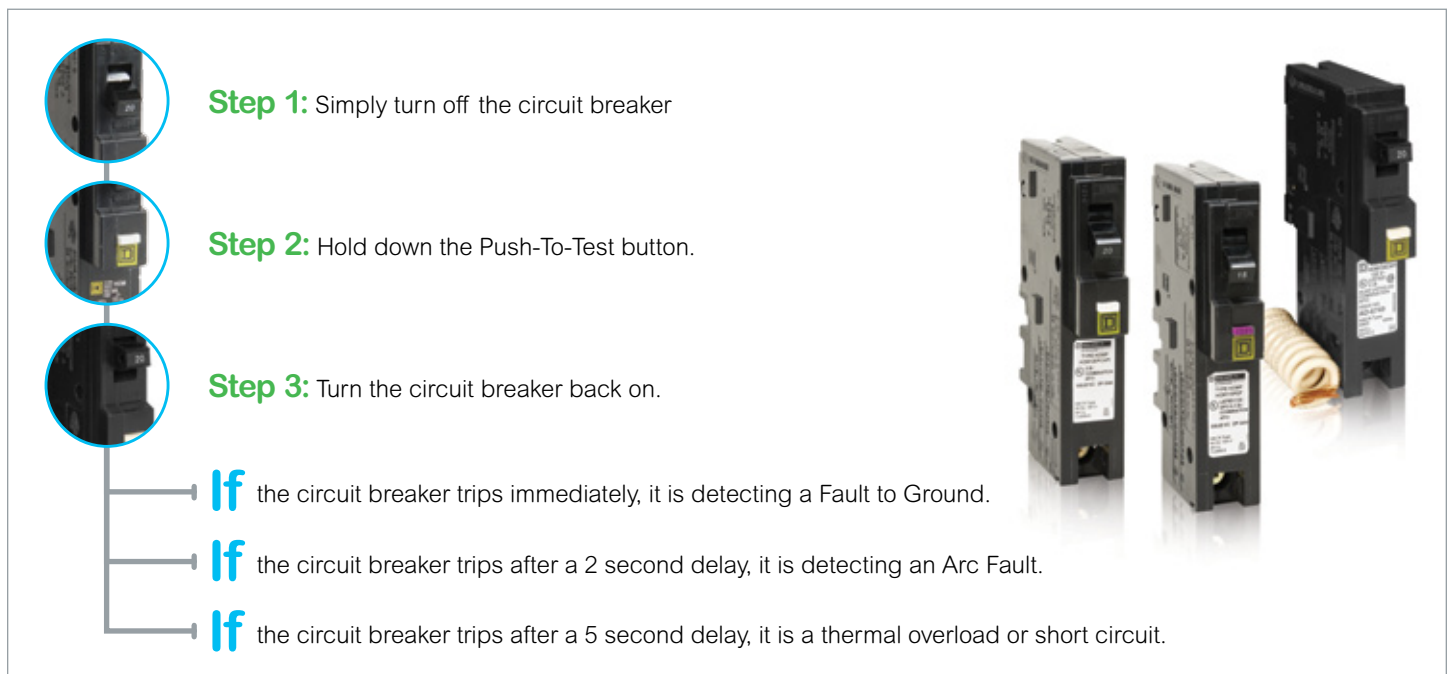

Step 1: Simply turn off the circuit breaker

Step 2: Hold down the Push-To-Test button.

Step 3: Turn the circuit breaker back on.

- If** the circuit breaker trips immediately, it is detecting a Fault to Ground.
- If** the circuit breaker trips after a 2 second delay, it is detecting an Arc Fault.
- If** the circuit breaker trips after a 5 second delay, it is a thermal overload or short circuit.



In any of these instances, it is an indication that there is an issue ON the circuit and NOT with the circuit breaker itself. (If there is no issue on the circuit to be diagnosed, tripping after a five second delay would also be a normal breaker testing operation.)



Control Switches

Float and Pressure Switches

For over 65 years, our Square D brand Pumptrol™ FSG Pressure Switches have been used to monitor and control electrically driven water pumps. A long-time industry standard, you can trust that Square D brand switches will do the necessary job every time.

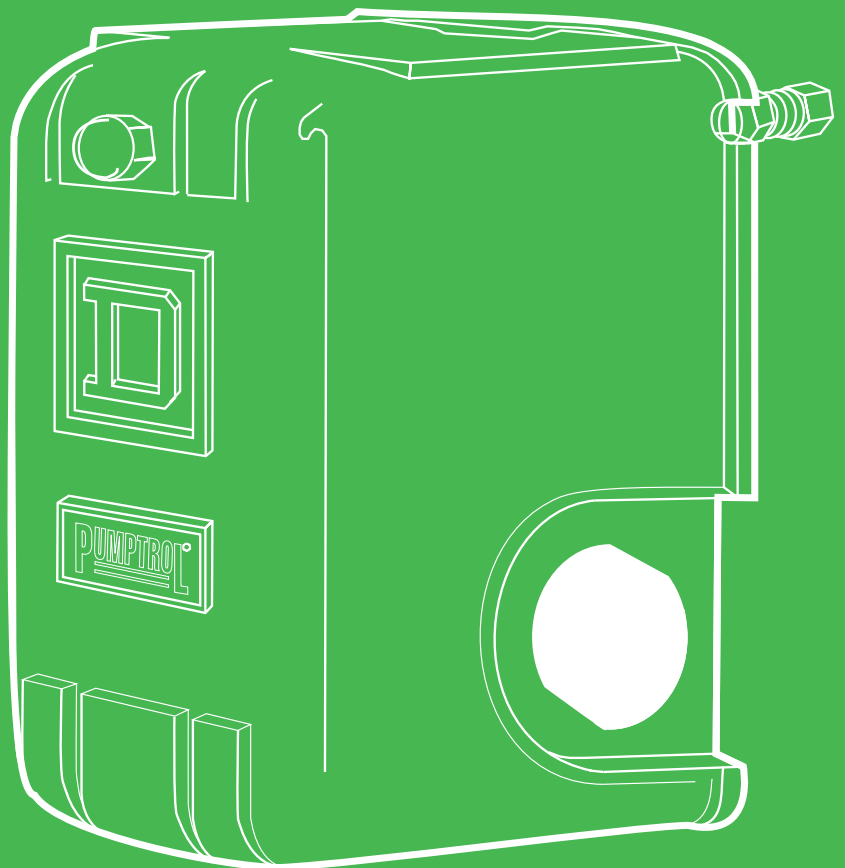

Square D introduced the FSG water pump switch in 1947. Today many more Square D brand switches are installed on pumps than any other switch available on the market.

Switches – Float

Pumptrol Float Switches Class 9036

Sump or Open Tank Style – Type FG			
Catalog #	UPC Code	Type	Description
9036FG	Special Order	—	Universal kit which includes switch, plastic center hole float, rod and attaching hardware
9036FG30	Special Order	Switch only	Contacts open or close on liquid rise 2-pole NEMA 1
9049A60	Special Order	Float	Plastic center hole float
9049A61	Special Order	Rod	33.75 inch aluminum rod, 2 float stop assemblies and attaching hardware

Sump or Open Tank Style – Type DG, GG						
Catalog #	UPC Code	Type	Description	Force up to trip	Force down to Trip	Level Position
9036DG2*	Special Order	Switch only	Contacts close on liquid rise	9 oz.	8 oz.	n/a
9036DG2R	7-85901-57643-3	Switch only	Contacts open on liquid rise	9 oz.	8 oz.	n/a
9036GG2*	Special Order	Switch only	Contacts close on liquid rise (Requires a 9049 float and rod kit)	33 (21) oz.	39 (27) oz.	short, (long)
9036GG2R*	7-85901-57543-6	Switch only	Contacts open on liquid rise (Requires a 9049 float & rod kit)	34 (21) oz.	40 (27) oz.	short, (long)
9049A6*	7-85901-59704-9	Tapped-at-Top float and rod kit	#304 SS float. 7" diameter 5' brass tubing and two stops	—	—	—
9049A6S	7-85901-59704-9	Float and rod kit	#304 SS float. 7" diameter 5' SS tubing and two stops	—	—	—
9049A6C	7-85901-59706-3	Center-Hole float and rod kit	#304 SS float. 7" diameter 5' brass tubing and four stops	—	—	—
9049A6CS	7-85901-59735-3	Float and rod kit	#304 SS float. 7" diameter 5' SS tubing and four stops	—	—	—
9049T1	7-85901-34988-4	Additional Tubing	2½' brass tubing with connector	—	—	—
9049T1S	7-85901-34990-7	Additional Tubing	2½' SS tubing with connector	—	—	—

* Item may require additional lead time.

- Pedestal Style Type FG30
 - Designed for liquid level control with electric motor operated pumps either directly or through a magnetic starter
 - Can also be used to activate alarms in liquid level control systems
 - Upward or downward movement of the lever arm of the Class 9036 Type FG30 float switch controls the ON and OFF positions corresponding to the water level changes required to turn the pump or alarm on and off
- Sump or Open Tank Type DG, GG
 - Double-pole rated, 3 phase
 - 2 HP @ 115 Vac and 3 HP @ 230 Vac
 - Designed for automatic control of liquid level in open sumps or tanks handling small motor loads directly or through a starter
 - NEMA Type 1 Indoor Enclosure
 - Type GG – heavier duty for light commercial and industrial applications.
- Double Pole Rated
 - 3HP @ 115V – 3 Phase
 - 5HP – 240V – 3 Phase



9036DG2



9036GG2



9036FG

Switches – Float

Pumptrol Float Switches Class 9037

Closed Tank – Screw-in Style – Type HG

Catalog #	UPC Code	Description	Float Position [▲]	Float Rod Angle	Approx. Water Level Change (Field Adjustable)	
					Minimum	Maximum
9037HG33*	Special Order	Contacts close on liquid rise	Right	45° offset	2"	5"
9037HG32	7-85901-07551-6	—	Left	90° offset	2"	11½"
9037HG31	Special Order	Contacts close on liquid rise	Right	90° offset	2"	11½"
9037HG30	Special Order	—	Left	90° offset	2"	8¼"

Closed Tank – Flange Mount Style – Type EG

Catalog #	UPC Code	Description	Post Length
9037EG8	Special Order	For minimum water level change	2½"
9037EG9	Special Order	For maximum water level change	2½"

* Item may require additional lead time.

▲ Viewed from front of switch facing indicator scale.

QUAD-RING[®] is a registered trademark of Minnesota Rubber Co.

VITON[®] is a registered trademark of DuPont Co.



9037EG

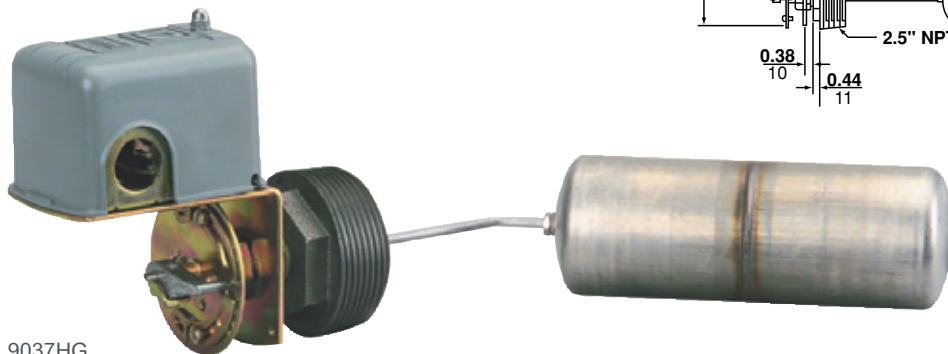

9037HG

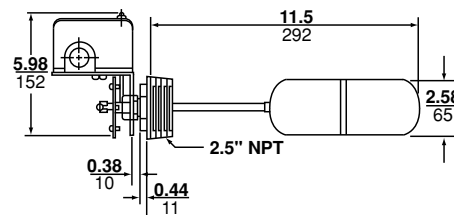
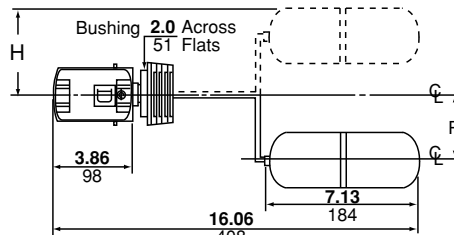
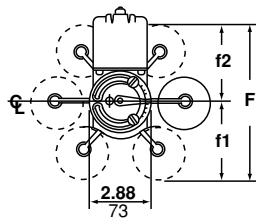
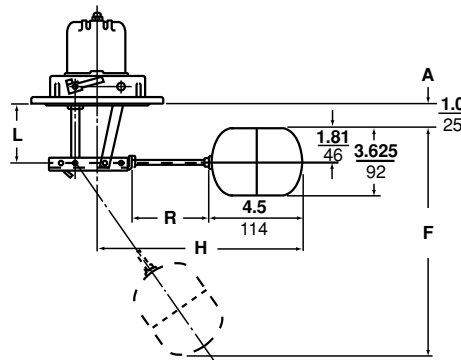

- Closed Tank-Type HG
 - NEMA Type 1 Indoor Enclosure
 - Double-pole rated
 - 2 HP @ 115 Vac and 3 HP @ 230 Vac
 - Type HG switch is attached to tank by means of 2½" threaded bushing
 - Switches come complete with stainless steel float and rod
 - Buna N Quad-Ring[®] seal is used between the float rod and sealing connector
 - Can withstand tank pressures up to 50 PSIG at temperatures up to 220°F
- Closed Tank-Type EG
 - NEMA Type 1 Indoor Enclosure
 - Double-pole rated, 3 phase
 - 2 HP @ 115 Vac 3 HP @ 230Vac
 - Switches are flange mounted and float movement is transmitted through a stuffing box – uses a quad ring seal
 - Can be built up to meet exact requirements from the basic switch, float rod and float groups
 - Switch may be assembled in the field to give contacts that open on liquid rise or close on liquid rise

Switches – Pressure

Pressure Switches

Catalog #	UPC Code	Cut-In Setting (PSIG)	Cut-Out Setting (PSIG)	Pressure Connection (NPSF Internal)	Additional Features*
Water Pump Pressure Switches – Type FSG*					
Standard Action: Contacts Open On Rising Pressure; 2-Pole, NEMA 1					
FSG2J20BP	0-47569-11533-2	20	40	1/4"	—
FSG2J20CP	0-47569-00632-6	20	40	1/4"	—
FSG2J20PBP	0-47569-11534-9	20	40	1/4"	Pulsation plug
FSG2J20PCP	0-47569-52171-3	20	40	1/4"	Pulsation plug
FSG2J20M1BP	0-47569-11535-6	20	40	1/4"	Manual cut-in lever
FSG2J20M1CP	0-47569-80786-2	20	40	1/4"	Manual cut-in lever
FSG2J20M4BP	0-47569-11536-3	20	40	1/4"	Low pressure cut-off
FSG2J20M4CP	0-47569-80787-9	20	40	1/4"	Low pressure cut-off
FSG2J18CP	Special Order	20	50	1/4"	—
FSG2J21BP	0-47569-11538-7	30	50	1/4"	—
FSG2J21CP	0-47569-80785-5	30	50	1/4"	—
FSG2J21M1BP	0-47569-11539-4	30	50	1/4"	Manual cut-in lever
FSG2J21M1CP	0-47569-04397-0	30	50	1/4"	Manual cut-in lever
FSG2J21M4BP	0-47569-11540-0	30	50	1/4"	Low pressure cut-off
FSG2J21M4CP	0-47569-03466-4	30	50	1/4"	Low pressure cut-off
FSG2J24BP	0-47569-11541-7	40	60	1/4"	—
FSG2J24CP	0-47569-07217-8	40	60	1/4"	—
FSG2J24M4BP	0-47569-11542-4	40	60	1/4"	Low pressure cut-off
FSG2J24M4CP	0-47569-17782-8	40	60	1/4"	Low pressure cut-off
Water Pump Pressure Switches – Type FRG**					
Reverse Action: Contacts Open On Falling Pressure; 2-Pole, NEMA 1					
9013FRG22J36	Special Order	10	5	1/4"	—
9013FRG22J19	Special Order	22	16	1/4"	—
9013FRG2J23	Special Order	40	20	1/4"	—
9013FRG2J23M3	Special Order	40	20	1/4"	Momentary manual cut-in lever (AUTO-START)
9013FRG2J23M5	Special Order	40	20	1/4"	Maintained manual cut-in lever (AUTO-ON)
9013FRG2J35	Special Order	50	30	1/4"	—
Water Pump Pressure Switches – Type FYG***					
Standard Action: Contacts Open On Rising Pressure; 2-Pole, NEMA 1 with higher HP					
9013FYG2J20	Special Order	20	40	1/4"	—
9013FYG2J21	Special Order	30	50	1/4"	—
9013FYG2J24	Special Order	40	60	1/4"	—
9013FYG2J33	Special Order	50	70	1/4"	—
9013FYG2J25	Special Order	60	80	1/4"	—

* FSG2 – 20-65 PSIG Cut-in Range, 10-45 PSIG Cut-out Range, 15-30 PSIG Approx. Adjustable Differential▲

** FRG2 – 23-65 PSIG Cut-in Range, 8-45 PSIG Cut-out Range, 15-30 PSIG Approx. Adjustable Differential▲

*** FRG22 – 10-45 PSIG Cut-in Range, 6-20 PSIG Cut-out Range, 4-25 PSIG Approx. Adjustable Differential▲

*** 9013FYG2 – 25-80 PSIG Cut-in Range, 5-60 PSIG Cut-out Range, 20-30 PSIG Approx. Adjustable Differential▲

▲ Differential – the difference between cut-in and cut-out pressure.



Class 9013 Type FSG

- Single-phase electrical ratings
 - FSG:
 - 1.5 HP @ 115 Vac
 - 2 HP @ 230 Vac
 - FRG:
 - 1 HP @ 115 Vac
 - 1 HP @ 230 Vac
 - FYG:
 - 2 HP @ 115 Vac
 - 3 HP @ 230 Vac
 - FHG:
 - 1.5 HP @ 115 Vac
 - 2 HP @ 230 Vac
 - GSG, GHG
 - 2 HP @ 115 Vac
 - 3 HP @ 230 Vac
 - 5 HP @ 460/575 Vac
- Additional features defined
 - Maintained manual cut-out lever has two positions: AUTO-switch operates on rising and falling pressure; and OFF – contacts are held in the open or off position.
 - Low pressure cut-off operates at approximately 10 PSIG below the cut-in setting to stop the pump in the event it runs dry or a line breaks.
 - Pulsation plug enables the switch to operate on reciprocating pump without responding to the pressure spikes at the end of each piston stroke.
 - 2-way pressure relief valve releases head pressure on the compressor upon cut-off of the switch.
 - CP: clamshell package, BP: box packaging.

Catalog #	UPC Code	Cut-Out Setting (PSIG)	Pressure Connection (NPSF Internal)	Additional Features*
Air Compressor Pressure Switches – Type FHG*				
Standard Action: Contacts Open On Rising Pressure; 2-Pole, NEMA 1				
FHG2J27BP	0-47569-11543-1	100	1/4"	—
FHG2J27CP	0-47569-17822-1	100	1/4"	—
FHG2J27XCP	0-47569-17823-8	100	1/4"	2-way pressure relief
FHG12J52XBP	0-47569-11545-5	125	1/4"	2-way pressure relief
FHG12J52XCP	0-47569-17824-5	125	1/4"	2-way pressure relief
FHG12J55BP	Special Order	150	1/4"	—
FHG12J55CP	0-47569-17825-2	150	1/4"	—
FHG12J55XBP	0-47569-11547-9	150	1/4"	2-way pressure relief
FHG12J55XCP	0-47569-17826-9	150	1/4"	2-way pressure relief
9013FHG42J59	Special Order	175	1/4"	—
9013FHG42J59X	Special Order	175	1/4"	—
9013FHG49J59	Special Order	175	1/4" NPT External	—
9013FHG49J59X	Special Order	175	1/4" NPT External	2-way pressure relief
Air Compressor Water Pump Pressure Switches – Type GHG, GSG**				
Standard Action: Contacts Open On Rising Pressure; 2-Pole, NEMA 1				
9013GSG2J20	Special Order	40	1/4"	—
9013GSG2J21	Special Order	50	1/4"	—
9013GSG2J24	Special Order	60	1/4"	—
9013GSG2J25	Special Order	80	1/4"	—
9013GHG2J25	Special Order	80	1/4"	—
9013GHG2J29	Special Order	100	1/4"	—
9013GHG2J30	Special Order	100	1/4"	—
9013GHG2J53	Special Order	125	1/4"	—
9013GHG2J63	Special Order	175	1/4"	—
9013GHG2J30X	Special Order	100	1/4"	2-way pressure relief
9013GHG2J53X	Special Order	125	1/4"	2-way pressure relief
9013GHG2J63X	Special Order	175	1/4"	2-way pressure relief

* FHG2 – 40-100 PSIG Cut-out Range, 20 PSIG Approx. Adjustable Differential▲

* FHG12 – 70-150 PSIG Cut-out Range, 30 PSIG Approx. Adjustable Differential▲

* FHG49 – 100-200 PSIG Cut-out Range, 40 PSIG Approx. Adjustable Differential▲

** 9013GSG2 – 5-60 PSIG Cut-out Setting, 20-80 PSIG Cut-out Range, 15-30 PSIG Approx. Adjustable Differential▲

** 9013GHG2 – 40-170 PSIG Cut-out Setting, 65-200 PSIG Cut-out Range, 20-40 PSIG Approx. Adjustable Differential▲

▲ Differential – the difference between cut-in and cut-out pressure.



Class 9013 Type GHG



Class 9013 Type FHG

Pressure Switches

Pumptrol Water Pump and Air Compressor Pressure Switches Class 9013

Schneider Electric Square D brand of pressure switches have set the standard for reliability, efficiency and durability. As the most trusted brand in residential, commercial and industrial pumping applications, Square D pressure switches continue to meet the daily needs of the water systems industry.

High reliability

- Rugged, robust construction provides a long life and provides years of uninterrupted, worry-free service
- Feature drift proof cut-in and cut-out settings
- Has visible vertical contacts, easy to inspect without removal
- Extra wide diaphragm orifice reduces clogging
- An extra strong frame that resists distortion when mounting the switch to a pipe or compressor
- Designed for the direct control of motors in pump and compressor applications. Water pump switches suitable for all types of pumps: jets, submersible, reciprocating, etc.
- Diaphragm actuated

Models

- Type FSG is the standard water pump switch
- Type FYG is designed to meet higher horsepower and pressure requirements
- Type FRG is reverse acting
- Type FHG for air compressors
- Type G for higher electrical ratings (water pumps and air compressors)



Safety Switches, Surge Protection & Other Residential Products

From the Beginning, the Safety Switch Leader

For more than 100 years, we've been the unchallenged leader in safety switches. Our Square D brand safety switches are preferred two to one over our closest competitor. We've continued our tradition of innovation, developing new features that provide an unsurpassed level of performance, reliability, safety and ease of installation.

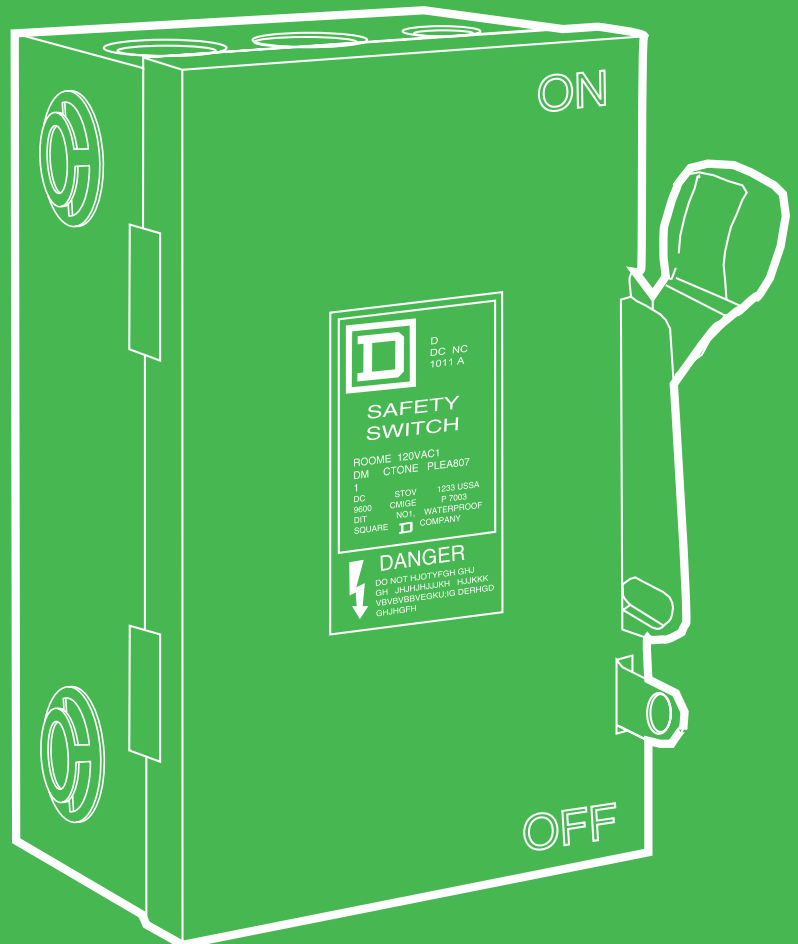

Square D introduced the enclosed safety switch back in 1909 and for more than 90 years we've been the unchallenged leader in safety switches.

AC Disconnects & Switches – Light Duty

Light and General Duty Switches Catalog Number Description

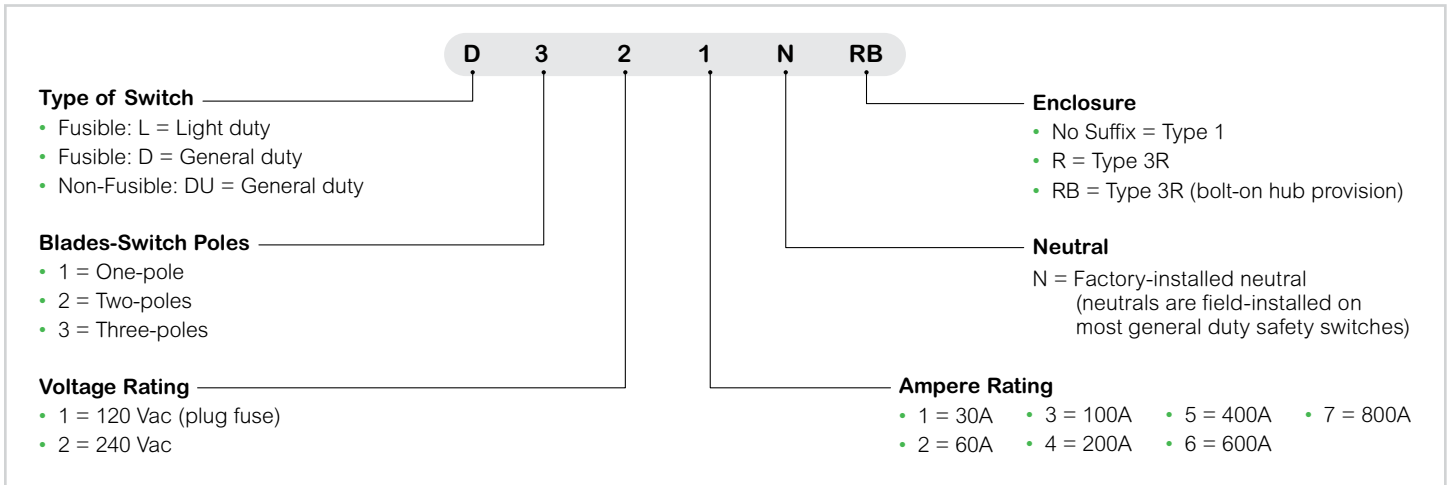

AC Disconnects

Amps	Catalog #	UPC Code	Maximum Horsepower	Add'l Access	UPC Code
Not Fusible AC Disconnects – Enclosed Molded Case Switch					
60	QO200TRCP	0-47569-51769-3	10	PKHB	7-85901-11935-7
Non-Metallic					
QO200TRNM			7-85901-32801-8		

AC Disconnects and Switches

AC Disconnects

- UL Listed
- 2 Wire
- 240 Vac
- Rainproof

Light Duty Enclosed Switches

- UL Listed
- 10kA Short Circuit Current Rating
- 120/240 Vac

Light Duty Switches

Amps	Fuse Type▼	System	Catalog #	UPC Code	Horsepower Rating
Fusible AC Disconnects – Pullout and Fuseholder▼					
30	Plug	2-Wire	L111N*	7-85901-11548-9	—
	Plug	3-Wire	L211N*	7-85901-09052-6	3 HP @ 240 Vac
	Cartridge	3-Wire	L221N▲	7-85901-49902-2	3 HP @ 240 Vac

▫ Suitable for use on systems with up to 10k RMS symmetrical amps with available fault current at 240 Vac max. when protected by a fuse or circuit breaker rated 60A or less.

● Bracket for QO200TR used for stucco, aluminum and vinyl siding available (Catalog No. PKHB/UPC Code 0-47569-11935-7).

▫ Does not contain overcurrent protection.

▼ Fuses not included.

* 10kA short circuit rating with plug fuses.

▲ 10kA short circuit rating with Class H fuses.



L211N



QO200TRNM



QO200TR

Switches – General Duty

Amps	Fuse Type	Indoor Unit Catalog #	UPC Code	Rainproof Unit Catalog #*	UPC Code
Fusible Safety Switches – 2-Pole, 3-Wire (2 Blades and Fuseholders, 1 Solid Neutral) 120/240 Vac (Plug), 240 Vac (Cartridge) Maximum					
30	Plug	D211NCP ^{●▼}	0-47569-52154-6	D211NRBCP ^{●▼}	0-47569-52160-7
	Cartridge	D221NCP [●]	0-47569-52155-3	D221NRBCP [●]	0-47569-52161-4
60	Cartridge	D222NCP [★]	0-47569-52156-0	D222NRBCP [★]	0-47569-52162-1
100	Cartridge	D223N [†]	7-85901-46068-8	D223NRB [†]	7-85901-46070-1
Fusible Safety Switches – 3-Pole, 4-Wire (3 Blades and Fuseholders, 1 Solid Neutral) 240 Vac Maximum					
30	Cartridge	D321NCP [●]	7-85901-07189-1	D321NRBCP [●]	7-85901-07190-7
60	Cartridge	D322N [★]	7-85901-46123-4	D322NRB [★]	7-85901-46128-9
100	Cartridge	D323N [†]	7-85901-46135-7	D323NRB [†]	7-85901-46140-1
Not Fusible Safety Switches – 2-Pole, 2-Wire (2 Blades) 240 Vac Maximum					
30	—	—	—	DU221RBUP [●]	7-85901-66562-5
60	—	—	—	QO260NATR ^{★●▼}	7-85901-62887-3
	—	QO260NATS ^{★●▼}	7-85901-62886-6	DU222RBUP [●]	7-85901-59167-2
100	—	QO2000NS ^{●▼}	7-85901-53952-0	QO2000NRB ^{●▼}	7-85901-53953-7
Not Fusible Safety Switches – 3-Pole, 3-Wire (3 Blades) 240 Vac Maximum					
30	—	DU321 [●]	7-85901-49160-6	DU321RB [●]	7-85901-49162-0
60	—	DU322 [●]	7-85901-49174-3	DU322RB [●]	7-85901-49176-7
100	—	DU323 [†]	7-85901-49180-4	DU323RB [▼]	7-85901-49182-8

General Duty Safety Switches

- UL Listed
- 10kA Short Circuit Withstand Rating with Proper Fuses Installed
- NEMA TYPE 1 Indoor
- NEMA Type 3RB Rainproof With Bolt On Hub Provision

● Enclosed molded case switch, not suitable for service equipment.

□ Includes ground bar kit, factory installed.

■ Includes solid neutral, factory installed.

* For bolt-on hubs, refer to Page 23.

● For field installable service ground bar kit order PK3GTA-1.

† For field installable service ground bar kit order GTK0610.

★ For field installable service ground bar kit order GTK03.

▼ 10kA short circuit current rating.



D223N



D221NRB



D222NRB

Switches – Circuit Breaker Enclosures

Amps	Service Vac	General Purpose Catalog #	UPC Code	Rainproof Catalog #	UPC Code	Box #	Circuit Breakers (order separately)	
							Amps	Catalog #
Enclosed Circuit Breakers (Includes factory installed circuit breakers) (see pg. 22-23)								
100	120/240	—	—	QO2100NRBCP	0-47569-51762-4	12R	—	—
200	120/240	—	—	QOM2E2200NRB	7-85901-37530-2	13R	—	—
Circuit Breaker Enclosures (circuit breakers not included: order QO and QO-GFCI breakers)								
100	120/240	QO2100BNS+	7-85901-05172-5	QO2100BNRB	7-85901-05174-9	17, 12R	—	—
	120/240	QO2100BNF+	7-85901-05173-2	—	—	17	—	—
	240	QO3100BNF+	7-85901-05175-6	QO3100BNRB+	7-85901-05177-0	17, 12R	—	—
	240	QO3100BNS+	7-85901-05176-3	—	—	17	—	—
125	120/240	QO2125BNF+	7-85901-05178-7	QO2125BNRB	7-85901-05180-0	22, 15R	—	—
	120/240	QO2125BNS+	7-85901-05179-4	—	—	22	—	—
Q-Frame Enclosures & Circuit Breakers (circuit breakers not included: enclosure only)								
—	—	—	—	—	—	—	100	QBL22100
—	—	—	—	—	—	—	110	QBL22110
—	—	—	—	—	—	—	125	QBL22125
—	240 – 2-Pole	Q2-2200NS	7-85901-78544-0	Q2-2200NRB	7-85901-78545-3	24, 13R	150	QBL22150
—	—	—	—	—	—	—	175	QBL22175
—	—	—	—	—	—	—	200	QBL22200
—	240 – 3-Pole	Q2-3225NF	7-85901-47060-1	Q2-3225NRB	7-85901-47062-5	25, 14R	100	QBL32100
—	240 – 3-Pole	Q2-3225NS	7-85901-47061-8	—	—	25	110	QBL32110
—	—	—	—	—	—	—	125	QBL32125
—	—	—	—	—	—	—	150	QBL32150
—	—	—	—	—	—	—	175	QBL32175
—	—	—	—	—	—	—	200	QBL32200
—	—	—	—	—	—	—	225	QBL32225



QO2100NRB



QOM2E2200NRB

Circuit Breaker Enclosures

- UL Listed

- ▶ All breakers rated at 10k AIC.
- For ground bar kit order PKOGTA-2.
- Accepts 200A max. 2-pole Q-Frame breakers.
- ▲ Factory-installed groundable neutral assembly included (2) ground lugs and (2) neutral lugs. Equipment ground kit PKOGTA-2 also included.
- ✦ Item may require additional lead time.

Whole House Surge Protection

Type	Catalog #	UPC Code	Surge Current (Per Phase)	Surgeologic Warranty/Down Stream Equipment Protection
Hardwire Secondary Surge Arrester				
Indoor/Outdoor	SDSA1175	7-85901-21087-0	36kA	Standard equipment warranty
Surgebreaker® Surge Protective Device				
QO	QO2175SB	7-85901-21089-4	22.5kA	\$10,000/3 year warranty
Homeline	HOM2175SB	7-85901-21090-0	22.5kA	\$10,000/3 year warranty
Home Electronics Protective Device				
Indoor/Outdoor	HEPD50*	7-85901-00662-6	50kA	\$50,000/3 year down stream warranty
Indoor/Outdoor	HEPD80	7-85901-00872-9	80kA	\$75,000/5 year down stream warranty
Indoor/Outdoor	HEPD80 (Clamshell)	7-85901-11283-9	80kA	\$75,000/5 year down stream warranty
Surgebreaker Plus				
Indoor	SDSB80111	7-85901-98058-2	80kA	\$100,000/5 year warranty and tel/cable protection

*Available 2017

Hard-Wire Whole House Surge Protective Device (SDSA1175)

- Suitable for Indoor and Outdoor Applications
- Suitable for Use in Service Entrance Locations: Meets Requirements of NEC Article 280
- Protects from Electrical Surges up to 36kA
- 150Vac Phase-to-Ground Maximum
- Equal Protection to all Circuits and Receptacles throughout the Home
- UL Listed 1449, 3rd Edition and CSA Certified



Surgebreaker for QO (QO2175SB) and Homeline (HOM2175SB)

- QO2175SB for QO load centers, combination devices and and NQ panelboards
- HOM2175SB for Homeline load centers and combination devices
- Plug-on design requires two pole spaces
- LED indicates operational status
- 22.5 kA per phase
- UL Listed 1449, 3rd Edition and CSA Certified
- 3 Year/\$10,000 Connected Equipment Limited Warranty



Home Electronics Protective Device (HEPD50, HEPD80)

- Small, affordable whole house surge suppression that can easily be mounted to Square D and competitors load centers
- Suitable for installing indoors or outdoors: NEMA 4X Rated
- Easy-to-install, optional flush mount kit for a professional look when installed in a finished wall (HEPD50MKF, HEPD80MKF)
- Longer service life and suppression of high-energy surges: 50 kA (HEPD50) and 80 kA (HEPD80) per phase maximum surge current
- LED Status Indicator
- 3 Year/\$50,000 (HEPD50) or 5 Year/\$75,000 (HEPD80) Connected Equipment Limited Warranty
- HEPD50: Type 2 Surge Protective Device. HEPD80: Type 1 Surge Protective Device
- UL Listed 1449, 3rd Edition and CSA Certified



Surgebreaker Plus Whole House Surge Protector (SDSB80111)

- Compact design requires minimal space
- Includes HEPD80 for long lasting protection against more powerful surges, up to 80 kA and offers 120/240V AC voltage protection
- Whole house protection including appliances, HVAC, lighting, cable, Ethernet, and telephone
- 5 Year/\$100,000 Connected Equipment Limited Warranty
- Removable modules (cable, Ethernet, and telephone) allow quick and easy installation customization
- UL Listed 1449, 3rd edition



Generator Panels

Indoor Generator Panel			
Amps	Catalog #	Ground Bar	UPC Code
30	QO48M30DSGP	PK7GTA	7-85901-86820-0
60	QO48M60DSGP	PK7GTA	7-85901-82434-3

Outdoor Generator Transfer Switch Panel				
Load Center Amps	Generator Main Amps	Catalog #	Power Inlet Type (included)	UPC Code
100	20	QO1DM10020TRBR	NEMA L14-20	7-85901-62331-1
	30	QO1DM10030TRBR	NEMA L14-30P	7-85901-88322-7
	50	QO1DM10050TRBR	Hubbell CS6375	7-85901-46880-6

Generator Interlock Kit				
Brand	Amp Rating	Catalog #	Indoor/Outdoor	UPC Code
QO	100-125A	QOCRBGK1C	Indoor - Outdoor	7-85901-61092-2
QO	150-225A	QOCGK2C*	Indoor	7-85901-48900-9
QO	150-225A	QORBGK2C	Outdoor	7-85901-61679-5
Homeline	100-125A	HOMCRBGK1C	Indoor-Outdoor	7-85901-59843-5
Homeline	150-225A	HOMCGK2C*	Indoor	7-85901-94050-0
Homeline	150-225A	HOMRBGK2C	Outdoor	7-85901-23316-9

* Exceptions: Older Series S1 Outdoor

Generator Panel

- Allows connection of up to eight circuits to a standby power source
- Safely switch from utility power to a standby power source with the flip of a switch on two QO main circuit breakers
- Mechanical interlock ensures that only one main circuit breaker is in the "ON" position at any time
- Uses eight genuine QO circuit breakers from Square D – "The World's Finest"
- 4 spaces/
8 circuits max

Generator Interlock Kit

- Direct generator power to any circuit within the home
- Interlocks the QOM1 and QOM2 main breaker with a 2-pole breaker back-fed from a generator
- No need for separate generator panel



QO48M30DSGP



Generator Interlock Kit (In use)

Advanced Products

Today's consumers are seeking ways to simplify and enhance their quality of life with products and services that suit their individual needs. For the first time, digital technology enables them to make their homes smarter, more energy efficient and controllable through products, software and services from Schneider Electric. Finding an easy plug and play solution that empowers them to monitor and adjust energy, fuel their electric vehicles, and much more.



Life Is On



Wiser Air – The smart thermostat, made Wiser.

Make the Wiser choice

Wiser Air™ is a home energy management solution that gives homeowners peace of mind through effortless control of comfort and savings.



WiserAir

The smart thermostat, made Wiser.

My Wiser
Designed to seamlessly fit your life with Simple Schedules and Ready Modes.

Sleek, Intuitive Design
The familiar, and informative, touch screen display makes interaction simple while Wiser Pulse emits a soft glow that indicates how the system is running.



Innovative Features
Wiser Air is packed with technology that drives friendly and unique features such as Comfort Boost to bring maximum comfort through just the touch of a button.

Eco IQ
Enable EcoIQ to let Wiser maximize the efficiency of the system based on the specific home and lifestyle; without sacrificing comfort.
* Features available in select areas.

Built in #1 Ranked Weather Service
With Wiser Forecast, Wiser Air adapts to what's happening outside using the #1 ranked weather service from Schneider Electric.

Auto Updates
Peace of mind, all the time. Wiser Air stays up-to-date through automatic updates that provide additional features and enhancements.

Make the Wiser choice.

Wiser Air is a home energy management solution that gives homeowners peace of mind through effortless control of comfort and savings.

Residential energy management

Wiser Air provides streamlined remote access across all major platforms. Be in control from anywhere at anytime.



Works with most common systems

- Forced air, radiant, heat pump (including geothermal), oil, gas and electric
- Up to 3 stages of heating
- Up to 2 stages of cooling

Ordering Information

• WISERAIR10BLKUS – Black

• WISERAIR10WHTUS – White

Wiser Air Specifications

Unit Dimensions	<ul style="list-style-type: none"> • 4in (10.2cm) H • 4in (10.2cm) W • 1.2in (3cm) D 	Wire Gauge	18 to 22 AWG (0.33 to 0.82mm ²)
Trim Plate Dimensions	<ul style="list-style-type: none"> • 4.8in (12.2cm) H • 6.3in (16cm) W • 0.1in (0.3cm) D 	Temperature	<ul style="list-style-type: none"> • Resolution: 1°F (0.5°C) • Control Accuracy: 1°F (0.5°C) • Cooling Setpoint Range: 48°F to 95°F (9°C to 35°C) • Heating Setpoint Range: 45.5°F to 92°F (7.5°C to 33°C) • Display Range: 40°F to 95°F (5°C to 35°C) • Remote Sensor Compatibility: 10k NTC, Type 2
Shipping Weight	1.32lb (599g)	Humidity Sensor	<ul style="list-style-type: none"> • Manufacturer Calibrated: not required • Precision: RH +/-3% • Dehumidification range: N/A
Screen	<ul style="list-style-type: none"> • 5.4cm (2.1in) H • 7.2cm (2.8in) W • 640 x 480 RGB 	Light Sensor	Application: LCD — Auto dim
Power Requirements	<ul style="list-style-type: none"> • Input: 24Vac (+/-15%), 50/60Hz • Consumption: 6VA • Maximum rating: 100VA, 4.17A • Class 2 circuits only 	Occupancy Sensor	<ul style="list-style-type: none"> • Application: LCD wake-up • Wiser Pulse intensity
Output Ratings	<ul style="list-style-type: none"> • Maximum output: 94VA • Relay rating: ~24Vac, 50/60Hz, 1A • In-rush = 3A • Connections: G, W, W2, Y, Y2, U, O/B • Class 2 circuits only 	Safety Standards	<ul style="list-style-type: none"> • UL 873 • CSA C22.2 No. 24-93
Operating Conditions	<ul style="list-style-type: none"> • Temperature: 32°F to 104°F (0°C to 40°C) • Humidity: 0% to 75% R.H. non-condensing 	EMC and Radio Standards	<ul style="list-style-type: none"> • EMC: FCC 15 Subpart B • ICES-003 • Radio: FCC 15 Subpart C • RSS 210
Storage Conditions	<ul style="list-style-type: none"> • Temperature: -22°F to 122°F (-30°C to 50°C) • Humidity: 0% to 75% R.H. non-condensing Indoor, Dry, Pollution Degree 2 	Network	<ul style="list-style-type: none"> • ZigBee (on-board) • Wi-Fi (802.11 b/g/n, 2.4GHz) • Open ADR ready



EVlink Charging Solutions

EVlink Electric Vehicle Charging Stations

EVlink™ Electric Vehicle Supply Equipment (EVSE) provides power to recharge the on-board vehicle batteries in Electric Vehicles (EV) and Plug-in Hybrid Electric Vehicles (PHEV).

The EVSE units are Level 2 type which can charge the vehicle batteries in as little as 3–6 hours, depending on the vehicle type and level of battery charge. The EVSE will typically be fed from a 208 or 240 V source, two-pole 40A circuit breaker or disconnect and will be able to provide 30A of current to the vehicle's on-board charger. All units meet or exceed SAE J1772^[1] and UL standards for electric vehicle supply equipment.

Schneider Electric EVSE features include:

- Integral Ground Fault Protection at 20 mA
- User friendly interface to indicate power on/off, charging, system detected faults etc.
- Heavy duty cord and connector which meet SAE J1772 standards
- Automatic reset and restart after ground fault or main power loss

EVlink charging Station

- Charging Station with advanced communications and networking
- DC fast charging station which can charge 80% of EV in less than 30 minutes

Please stay tuned at www.schneider-electric.us/go/evlink

^[1] SAE J1772—standard for Electric Vehicles that defines common connectors and interfaces at various power levels for PHEV and EV established by Society of Automotive Engineers for North America.

Indoor Charging Station

Input Voltage System	Application	Output Current	Mounting	Number of Charging Units	Catalog Number
208–240 Vac	Indoor	30 A ^[1]	Wall	Single	EV230WS

Indoor Charging Stations

The diagram illustrates the components of the indoor EV charging station. On the left is a close-up of the user interface, which includes a segmented progress indicator, a stop button, power status indicators, and a delay button. The main unit is a white, wall-mounted enclosure with a green accent. A black cable is held in a separate white cable holder, and the charging connector is shown at the end of the cord.

Enclosure:

- Non-metallic
- Indoor wall-mount (stud, drywall, or masonry wall)

Cable Holder:

- Supports and helps organize the cable
- Mounted independently from the enclosure

Connector and Cord:

- Complies with SAE J1772
- Cable length: 18 ft. (5.5 m)

Interface:

- Segmented charge and delay charge progress indicator
- Stop button and indicator
- Power status and system detected fault indicator
- Delay button and indicator

Protection:

- Integral Ground Fault Protection at 20 mA
- Ground fault function tested before each charge cycle begins
- Auto restart after ground fault or main power loss

Outdoor Charging Stations

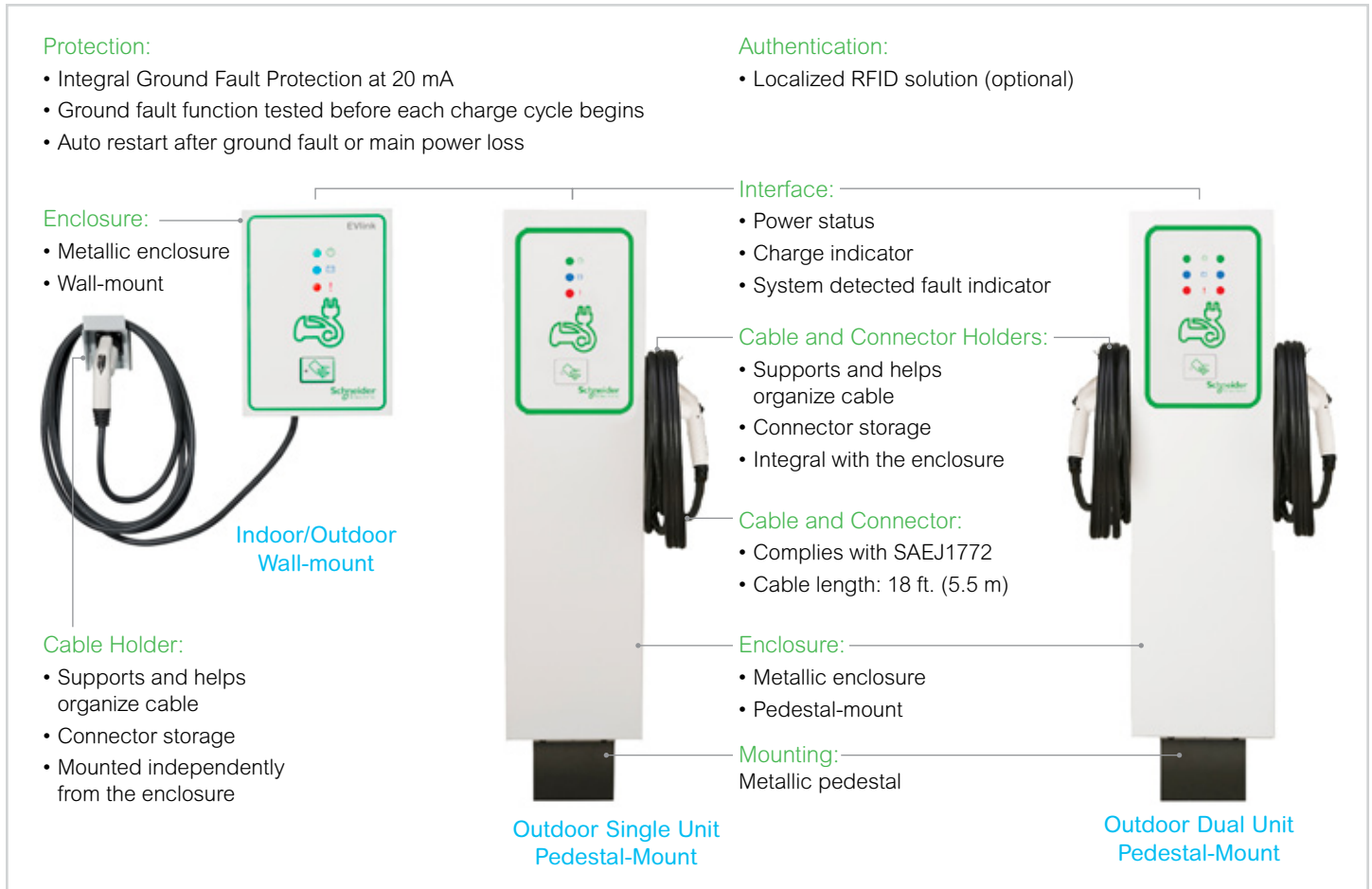

Outdoor Charging Stations

Output Voltage System	Application	Output Current	Mounting	Enclosure Type	Number of Charging Units	Catalog Number
208–240 Vac	Indoor/Outdoor	30 A ^[3]	Wall	3R	Single	EV230WSR
208–240 Vac	Outdoor	30 A ^[3]	Pedestal	3R	Single	EV230PSR
208–240 Vac	Outdoor	30 A ^[3]	Pedestal	3R	Dual ^[4]	EV230PDR

Outdoor Charging Stations with RFID Accessories

Output Voltage System	Application	Output Current	Mounting	Enclosure Type	Number of Charging Units	Catalog Number
208–240 Vac	Indoor/Outdoor	30 A ^[3]	Wall	3R	Single	EV230WSRR
208–240 Vac	Outdoor	30 A ^[3]	Pedestal	3R	Single	EV230PSRR
208–240 Vac	Outdoor	30 A ^[3]	Pedestal	3R	Dual ^[5]	EV230PDRR



EVRFIDHP

RFID Authentication Cards (for Applicable Level 2 Charging Stations only)^[6]

Description	Catalog Number
RFID Handheld Programmer	EVRFIDHP
RFID Authentication Cards (Quantity of 10)	EVRFIDKF10



EVRFIDKF10

^[3] Feeder circuit breaker size = 40 A

^[4] Output current per charge unit.

^[5] Output current per charge unit.

^[6] Required for charging stations with RFID Accessories.

EVlink Electric Vehicle Charging Stations Dimensions

Dimension: in. (mm)

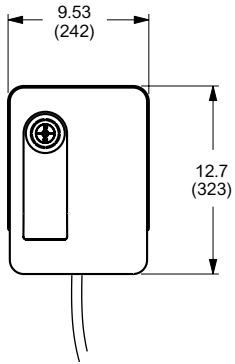
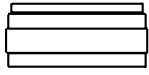

Indoor Wall-mount

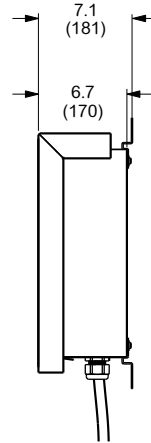
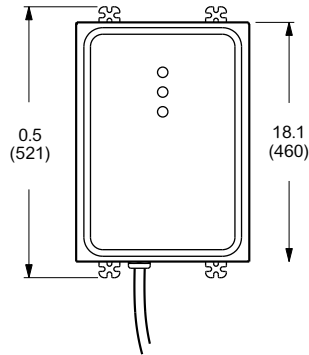
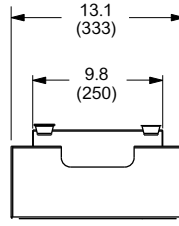

Indoor/Outdoor Wall-mount

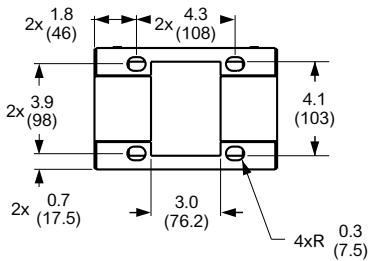
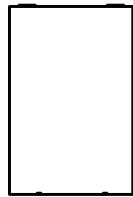
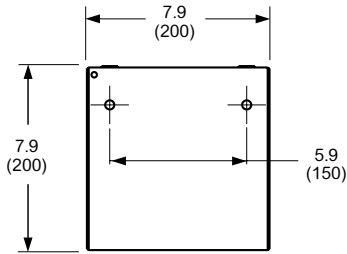

Bottom View

Pedestal Base

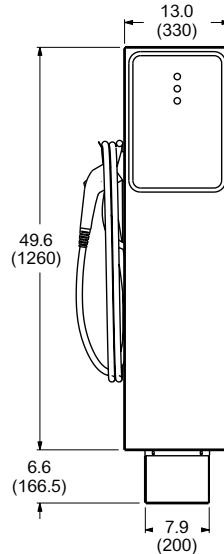
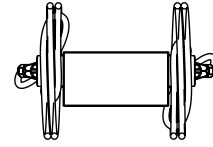
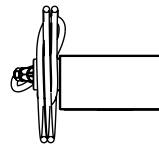

Single Unit

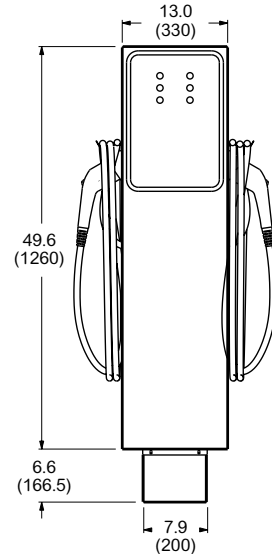

Dual Unit

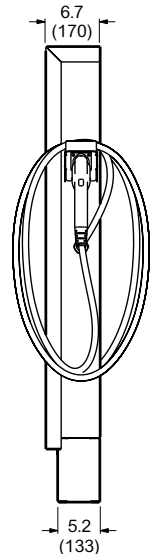

Pedestal-Mounted Charging Stations



Control panel of the Schneider Electric charging station. It features a grid of colored buttons (green, blue, red) and a central green logo consisting of a stylized 'E' and 'S' with a plug. Below the logo, the text 'Schneider Electric' is visible.

Important Information

Product Warranty

Square D/Schneider Electric Residential Products Limited Warranty

Schneider Electric warrants equipment manufactured by it and sold through authorized sales channels to be free from defects in materials and workmanship. The duration of the warranty is specified in Seller's technical library. The warranty starts from the date of invoice of the products. If the invoice date of the relevant products cannot be determined for any reason whatsoever, the warranty starts as of the manufacturing date code that is specified on each product, in which case the duration of the warranty as specified in Seller's technical library will be extended by 6 months. If within such period any such equipment shall be proved to Schneider Electric's satisfaction to be non-conforming, such equipment shall be repaired or replaced at Schneider Electric's option. This warranty shall not apply (a) to equipment not manufactured by Schneider Electric, (b) to equipment that has been repaired or altered by other than Schneider Electric so as, in its judgment, to affect the same adversely, or (c) to equipment that has been subjected to negligence, accident, or damage by circumstances beyond Schneider Electric's control, or improper operation, maintenance or storage, or to other than normal use or service. With respect to equipment not manufactured by Schneider Electric, the warranty obligations of Schneider Electric shall in all respects conform and be limited to the warranty actually extended to Schneider Electric by its supplier.

Nonconforming products must be returned at Schneider Electric's expense for evaluation unless this is waived in writing. Replacement products may be new or reconditioned. The foregoing warranties do not cover reimbursement for labor, transportation, removal, installation, temporary power, or any other expenses that may be incurred in connection with repair or replacement. The repairing of, changes to, or replacement of the product or part of it during the warranty period shall in no case cause the product-warranty period to be extended. Warranty is voided on genuine Schneider Electric products if they are reconditioned. There is no warranty on counterfeit products.



Questions?

Call Our Customer Care Center at: 1-888-SQUARED (888-778-2733)



Life Is On



by Schneider Electric



dealers
electrical
supply

Authorized Partner

(903)353-3974

bfadal@dealerselectrical.com

Dealers Electric Supply

www.dealerselectrical.net

Schneider Electric USA, Inc.

800 Federal Street

Andover, MA 01810

888 SQUARED (888 778 2733)

www.schneider-electric.com/us

July 2016

Document Number RP19530716

This document has been
printed on recycled paper



©2016 Schneider Electric. All Rights Reserved. Schneider Electric, EVLink, HomeLine, Life is On, Schneider Electric, Pumptrol, QO, Qwik Open, Square D, Visi-Tip and Wiser are trademarks and the property of Schneider Electric SE, its subsidiaries and affiliated companies. All other trademarks are the property of their respective owners.